



OPTISOUND 3030 C Quick setup guide

Ultrasonic Level Transmitter

Foundation Fieldbus



KROHNE

Contents

1	For your safety	3
1.1	Authorised personnel	3
1.2	Appropriate use.....	3
1.3	Warning about incorrect use.....	3
1.4	General safety instructions	3
1.5	EU conformity.....	3
1.6	NAMUR recommendations	4
2	Product description	5
2.1	Configuration.....	5
3	Mounting.....	6
3.1	Mounting instructions	6
4	Connecting to power supply.....	7
4.1	Connection procedure.....	7
4.2	Wiring plan, single chamber housing.....	8
4.3	Wiring plan, double chamber housing	8
5	Set up with the display and adjustment module PLICSCOM	9
5.1	Insert display and adjustment module	9
5.2	Setup steps	9
5.3	Menu schematic.....	12
6	Supplement	14
6.1	Technical data	14



Information:

This quick setup guide enables quick setup and commissioning of your instrument.

You can find further information in the corresponding, comprehensive operating instructions as well as in the Safety Manual for instruments with SIL qualification.

Operating instructions OPTISOUND 3030 C - Foundation Fieldbus: Document-ID 51118

Editing status of the quick setup guide: 2022-03-07

1 For your safety

1.1 Authorised personnel

All operations described in this documentation must be carried out only by trained, qualified personnel authorised by the plant operator. During work on and with the device, the required personal protective equipment must always be worn.

1.2 Appropriate use

OPTISOUND 3030 C is a sensor for continuous level measurement. You can find detailed information about the area of application in chapter " *Product description*".

Operational reliability is ensured only if the instrument is properly used according to the specifications in the operating instructions manual as well as possible supplementary instructions.

1.3 Warning about incorrect use

Inappropriate or incorrect use of this product can give rise to application-specific hazards, e.g. vessel overflow through incorrect mounting or adjustment. Damage to property and persons or environmental contamination can result. Also, the protective characteristics of the instrument can be impaired.

1.4 General safety instructions

This is a state-of-the-art instrument complying with all prevailing regulations and directives. The instrument must only be operated in a technically flawless and reliable condition. The operator is responsible for the trouble-free operation of the instrument. When measuring aggressive or corrosive media that can cause a dangerous situation if the instrument malfunctions, the operator has to implement suitable measures to make sure the instrument is functioning properly.

The safety instructions in this operating instructions manual, the national installation standards as well as the valid safety regulations and accident prevention rules must be observed by the user.

For safety and warranty reasons, any invasive work on the device beyond that described in the operating instructions manual may be carried out only by personnel authorised by the manufacturer. Arbitrary conversions or modifications are explicitly forbidden. For safety reasons, only the accessory specified by the manufacturer must be used.

To avoid any danger, the safety approval markings and safety tips on the device must also be observed.

1.5 EU conformity

The device fulfils the legal requirements of the applicable EU directives. By affixing the CE marking, we confirm the conformity of the instrument with these directives.

The EU conformity declaration can be found on our homepage.

1.6 NAMUR recommendations

NAMUR is the automation technology user association in the process industry in Germany. The published NAMUR recommendations are accepted as the standard in field instrumentation.

The device fulfils the requirements of the following NAMUR recommendations:

- NE 21 – Electromagnetic compatibility of equipment
- NE 43 – Signal level for fault information from measuring transducers
- NE 53 – Compatibility of field devices and display/adjustment components

For further information see www.namur.de.

2 Product description

2.1 Configuration

Type label

The type label contains the most important data for identification and use of the instrument:

- Instrument type
- Article and serial number device
- Article number documentation
- Technical data: Approvals, process temperature, process fitting/material, signal output, voltage supply, protection

3 Mounting

3.1 Mounting instructions

Reference plane for measuring range

The reference plane for the measuring range is the lower edge of the transducer.

Make sure that a minimum distance from the reference plane - the so-called dead zone, in which measurement is not possible - is maintained. The exact value of the dead zone is stated in chapter "Technical data".

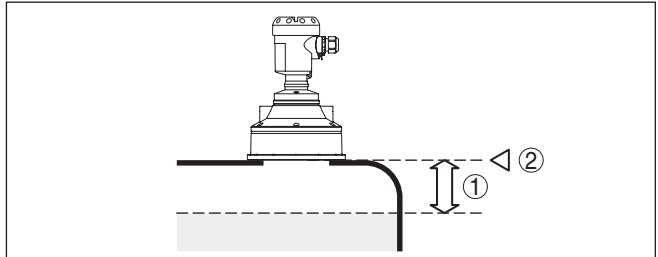

Fig. 1: Minimum distance to the max. level

- 1 blocking distance
- 2 Reference plane

Mounting

Mount the sensor at least 200 mm (7.874 in) away from the vessel wall.

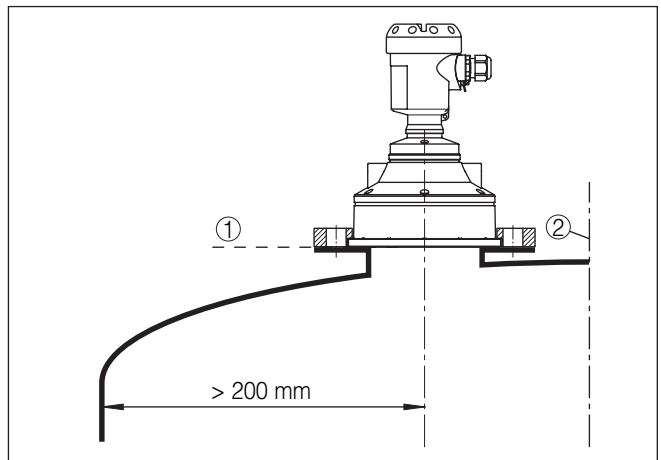

Fig. 2: Mounting on round vessel tops

- 1 Reference plane
- 2 Vessel center or symmetry axis

4 Connecting to power supply

4.1 Connection procedure

Proceed as follows:

1. Unscrew the housing lid
2. If a display and adjustment module is installed, remove it by turning it to the left
3. Loosen compression nut of the cable gland and remove blind plug
4. Remove approx. 10 cm (4 in) of the cable mantle, strip approx. 1 cm (0.4 in) of insulation from the ends of the individual wires
5. Insert the cable into the sensor through the cable entry
6. Lift the opening levers of the terminals with a screwdriver (see following illustration)
7. Insert the wire ends into the open terminals according to the wiring plan



Fig. 3: Connection steps 6 and 7

8. Press down the opening levers of the terminals, you will hear the terminal spring closing
9. Check the hold of the wires in the terminals by lightly pulling on them
10. Connect the shielding to the internal ground terminal, connect the external ground terminal to potential equalisation
11. Tighten the compression nut of the cable entry gland. The seal ring must completely encircle the cable

12. Screw the housing lid back on
The electrical connection is finished.

4.2 Wiring plan, single chamber housing

Wiring plan

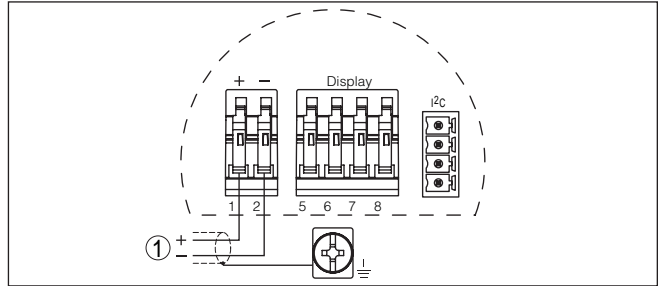

Fig. 4: Wiring plan - single chamber housing

1 Voltage supply, signal output

4.3 Wiring plan, double chamber housing

Wiring plan

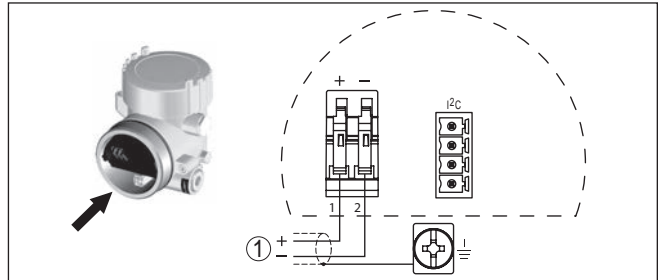

Fig. 5: Wiring plan - double chamber housing

1 Voltage supply, signal output

5 Set up with the display and adjustment module PLICSCOM

Mount/dismount display and adjustment module

5.1 Insert display and adjustment module

The display and adjustment module can be inserted into the sensor and removed again at any time. It is not necessary to interrupt the voltage supply.

Proceed as follows:

1. Unscrew the housing lid
2. Place the display and adjustment module in the desired position on the electronics (four positions in 90° offset can be selected) and turn to the right until it clicks into place.
3. Screw housing lid with inspection window tightly back on

Disassembly is carried out in reverse order.

The display and adjustment module is powered by the sensor, an additional connection is not necessary.

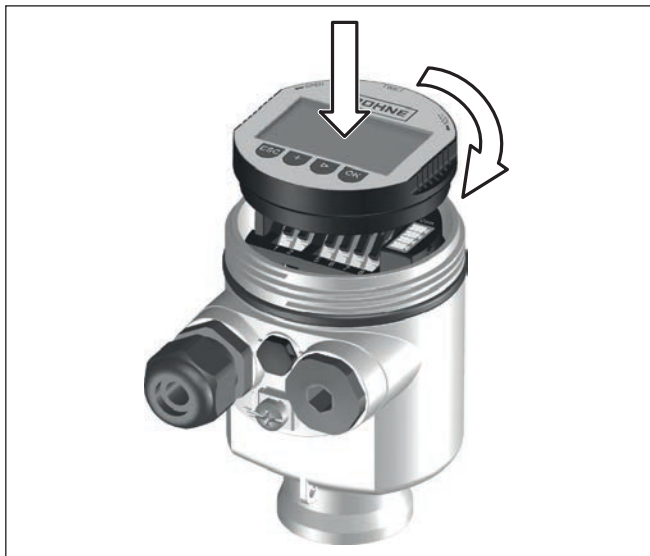

Fig. 6: Insert display and adjustment module in the single chamber housing



Note:

If you intend to retrofit the instrument with a display and adjustment module for continuous measured value indication, a higher lid with an inspection glass is required.

5.2 Setup steps

1. Go to the menu "Basic adjustment" via the display and adjustment module.

Set parameters

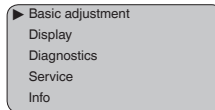

2. Carry out the adjustment in the menu items "*Min. adjustment*" and "*Max. adjustment*".

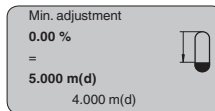
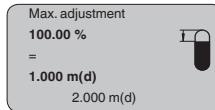

3. Select in the menu item "*Medium*" the medium of your application, for example "*Aqueous solution*".

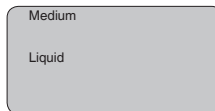

4. Select in the menu item "*Application*" the vessel, the application and the vessel form, for example, "*Storage tank*".

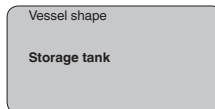

Parameter adjustment

The sensor measures the distance from the sensor to the medium surface. For indication of the real level, an allocation of the measured distance to the percentage height must be carried out.

The actual level is then calculated on the basis of these entered values. At the same time, the operating range of the sensor is limited from maximum range to the requested range.

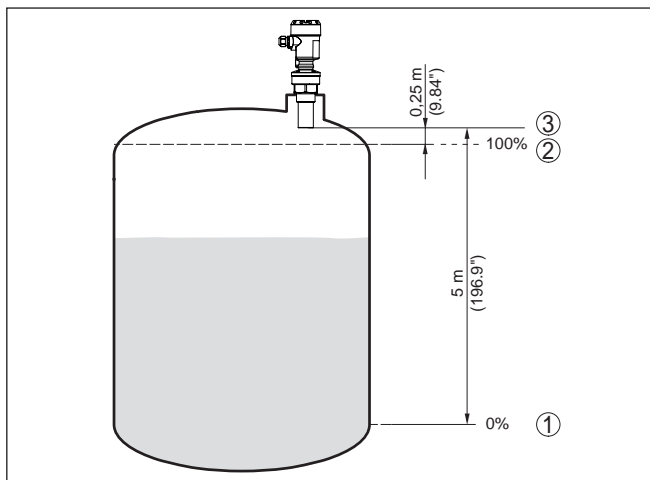

Fig. 7: Parameterisation example, Min./max. adjustment

- 1 Min. level = max. distance (depending on the sensor)
- 2 Max. level = min. distance (final value of the blocking distance, depending on the sensor)
- 3 Reference plane

The actual product level during this adjustment is not important, because the min./max. adjustment is always carried out without changing the product level. These settings can be made ahead of time without the instrument having to be installed.

Service - False signal suppression

High nozzles or vessel installations, such as e. g. struts or agitators as well as buildup and weld joints on the vessel walls, cause interfering reflections which can impair the measurement. A false echo storage detects and marks these false echoes, so that they are no longer taken into account for the level measurement. A false echo memory should be created with low level so that all potential interfering reflections will be detected.

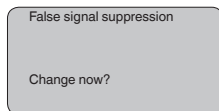

Proceed as follows:

1. Move from the measured value display to the main menu by pushing **[OK]**.
2. Select the menu item "Service" with **[->]** and confirm with **[OK]**. Now the menu item "False signal suppression" is displayed.
3. Confirm "False signal suppression - Change now" with **[OK]** and select in the below menu "Create new". Enter the actual distance from the sensor to the medium surface. All false signals in this area are detected by the sensor and saved after confirming with **[OK]**.

**Note:**

Check the distance to the medium surface, because if an incorrect (too large) value is entered, the existing level will be saved as a false signal. The level would then no longer be detectable in this area.

5.3 Menu schematic**Information:**

Depending on the version and application, the highlighted menu windows may not always be available.

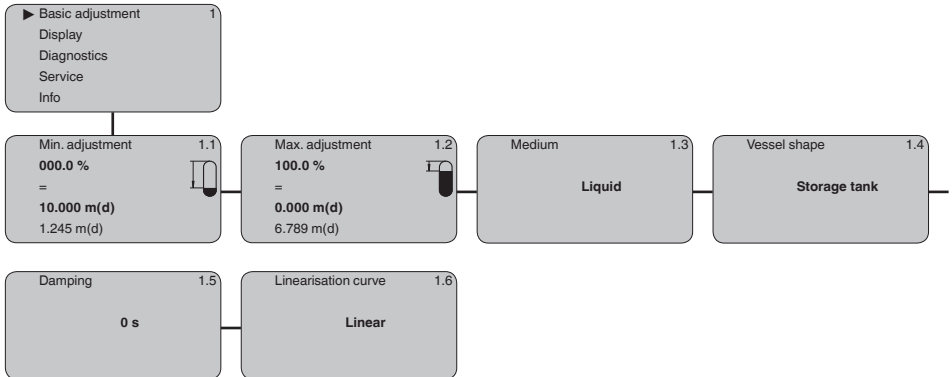
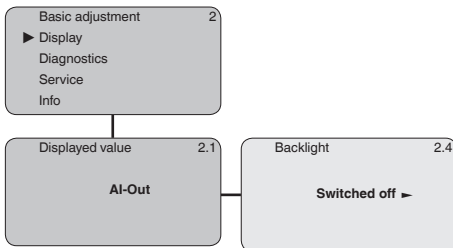
Basic adjustment**Display**

Diagnostics

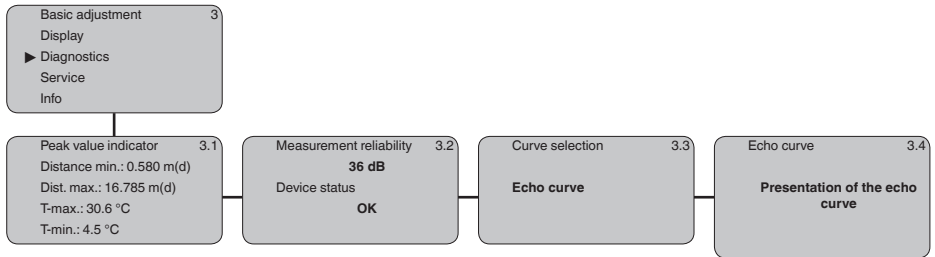

Service

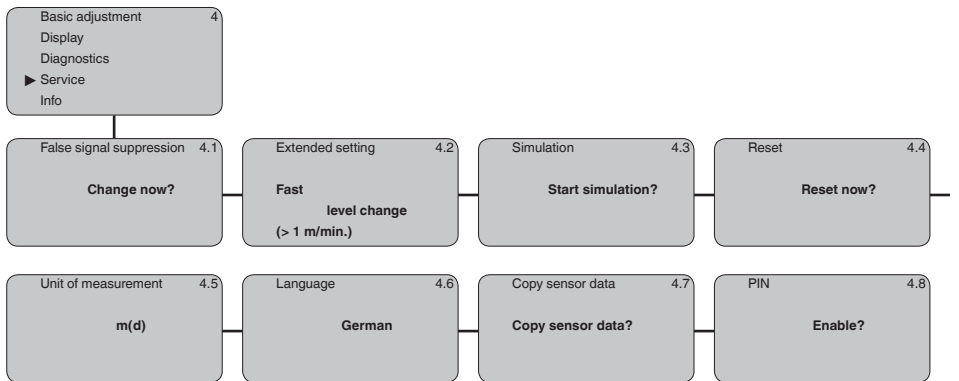

Info

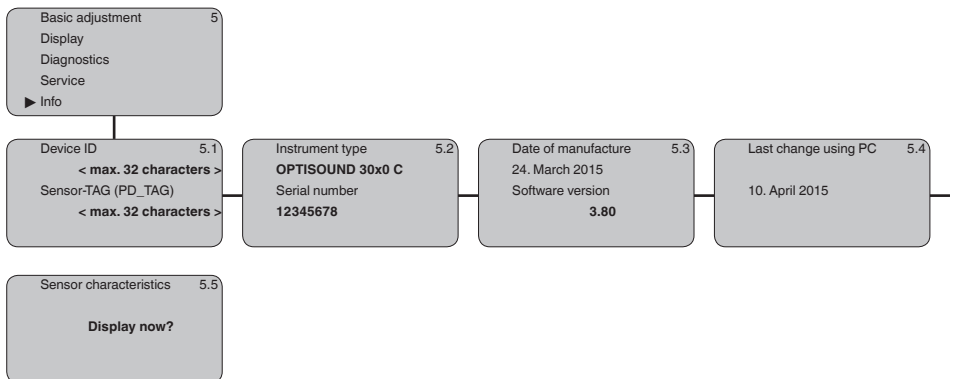

6 Supplement

6.1 Technical data

Note for approved instruments

The technical data in the respective safety instructions which are included in delivery are valid for approved instruments (e.g. with Ex approval). These data can differ from the data listed herein, for example regarding the process conditions or the voltage supply.

All approval documents can be downloaded from our homepage.

Input variable

Measured variable	distance between lower edge of the transducer and medium surface
Measuring range	
– Liquids	up to 15 m (49.21 ft)
– Bulk solids	up to 7 m (22.97 ft)
blocking distance	0.6 m (1.969 ft)

Electromechanical data

Cable entry

– Single chamber housing	– 1 x cable gland M20 x 1.5 (cable: \varnothing 5 ... 9 mm), 1 x blind plug M20 x 1.5 or: – 1 x closing cap $\frac{1}{2}$ NPT, 1 x blind plug $\frac{1}{2}$ NPT
– Double chamber housing	– 1 x cable gland M20 x 1.5 (cable: \varnothing 5 ... 9 mm), 1 x blind plug M20 x 1.5 or: – 1 x closing cap $\frac{1}{2}$ NPT, 1 x blind plug $\frac{1}{2}$ NPT

Spring-loaded terminals for wire cross-section up to	2.5 mm ² (AWG 14)
--	------------------------------

Voltage supply

Operating voltage	9 ... 32 V DC
Operating voltage U_B with lighting switched on	12 ... 32 V DC
Power supply by/max. number of sensors	32



KROHNE - Products, Solutions and Services

- Process instrumentation for flow, level, temperature, pressure measurement and process analytics
- Flow metering, monitoring, wireless and remote metering solutions
- Engineering, commissioning, calibration, maintenance and training services

Head Office KROHNE Messtechnik GmbH
Ludwig-Krohne-Straße 5
47058 Duisburg (Germany)
Tel.: +49 (0) 203 301 0
Tel.: +49 (0) 203 301 10389
info@krohne.de

The current list of all KROHNE contacts and addresses can be found at:
www.krohne.com

KROHNE