

## Short form installation and operating instructions

# Universal 3-Beam ultrasonic flowmeter

UFM 3030 ultrasonic flowmeter  
UFC 030 ultrasonic flow converter  
UFS 3000 ultrasonic flow sensor



---

Electromagnetic flowmeters

---

Variable area flowmeters

---

Mass flowmeters

---

**Ultrasonic flowmeters**

---

Vortex flowmeters

---

Flow controllers

---

Level measuring instruments

---

Pressure and temperature

---

Heat metering

---

Communications technology

---

Switches, counters, displays and recorders

---

Engineering systems & solutions

---

---

---

## General advice on safety

---

- Do not install, operate or maintain this flowmeter without reading, understanding and following the factory-supplied instructions, otherwise injury or damage may result.
- Read these instructions carefully before starting installation and save them for future reference.
- Observe all warnings and instructions marked on the product.
- Use only mains supply with protective earthing connected.
- Do not use the product with removed covers under wet conditions.
- Consider handling and lifting instructions to avoid damage.
- Install the product securely and stable.
- Install and connect cabling proper to exclude damage or harmful situations.
- If the product does not operate normally, refer to the service instructions or refer to qualified KROHNE service engineers.
- There are no operator-serviceable parts inside the product.

The following symbols may appear in this manual or on the product



ATTENTION: refer to operating and installation instructions!



DANGER: risk of electric shock!



PROTECTIVE conductor terminal!

These terms may appear in this manual or on the product:



WARNING statement: identify conditions or practice that could result in injury or loss of life.



CAUTION statement: identify conditions or practice that could result in damage to the product or other property.

---

## **Disclaimer**

---

- This document contains important information on the product. KROHNE attempts to be as accurate and up-to-date as possible but assumes no responsibility for errors or omissions. Nor does KROHNE make any commitment to update the information contained herein. This manual and all other documents are subject to change without prior notice.
- KROHNE will not be liable for any damage of any kind by using its product, including, but not limited to direct, indirect, incidental, punitive and consequential damages.
- This disclaimer does not apply in case KROHNE has acted on purpose or with gross negligence. In the event any applicable law does not allow such limitations on implied warranties or the exclusion of limitation of certain damages, you may, if such law applies to you, not be subject to some or all of the above disclaimer, exclusions or limitations.
- Any product purchased from KROHNE is warranted in accordance with the relevant product documentation and our Terms and Conditions of Sale.
- KROHNE reserves the right to alter the content of its documents, including this disclaimer in any way, at any time, for any reason, without prior notification, and will not be liable in any way for possible consequences of such changes.

---

## **Product liability and warranty**

---

- Responsibility for suitability and intended use of this ultrasonic flowmeter rests solely with the user. Improper installation and operation of the flowmeter (system) may lead to loss of warranty.
- In addition, the Terms and Conditions of Sale are applicable and are the basis for the purchase contract.
- If flowmeters need to be returned to KROHNE, please note the information given on the last pages of the installation and operating instructions. KROHNE regrets that they cannot repair or check flowmeter(s) unless accompanied by the completed form (see last pages of the installation and operating instructions).

---

## **Items included with order**

---

- UFM 3030 ultrasonic flowmeter, comprising of a flow sensor, UFS3000 and a signal converter, UFC 030 either built together as a compact system or supplied as two separate pieces, in the size as indicated on the packaging box
- Signal cable (only in case of a separate system)
- Special tool for opening the converter housing

---

## **Documentation supplied**

---

- Condensed installation and operating manual
- For Ex-units: installation and operating instructions for use in hazardous areas
- Service Handbook
- Approval documents, unless reproduced in the installation and operating instructions
- Report of factory settings of the signal converter
- Certificate of system calibration data

---

---

## System Installation and Start-up

---

### 1 Introduction

---

#### 1.1 Cautions

Only for flowmeters supplied with a voltage over 50 VAC.



**Refer all maintenance or service to trained KROHNE service engineers.**

Mains power shall be disconnected from the product before performing any maintenance.

This product is prepared for and can only function with the rated AC mains or DC supply voltage as indicated on the nameplate.

For 100 – 240 VAC supplied flowmeters: this product is a Class 1 device (earthed) and requires a correct connection to protective earth. The protective earth conductor of the main power shall be properly connected to the marked protective earth terminal to ensure safety from electric shock for the operator and its environment. For detail refer to this service handbook.

#### 1.2 Unpacking and inspection

- This product has been thoroughly inspected and tested before shipment and is ready for operation.
- After carefully unpacking, inspect for shipping damage before attempting to operate. If any indication of mechanical damage is found contact immediately the responsible transport service and your local KROHNE representative.
- A simple operating check of the electronics after unpacking and before permanent installation is advisable to ascertain whether it has suffered damage during shipment. Confirm for the correct mains voltage printed on the nameplate. If it differs from the ordered product please contact your local KROHNE representative.
- After connecting to the mains, check if there is any indication on the display and if the backlight of the display is lighted. If not, contact your local KROHNE representative for advice.

#### 1.3 System description

The UFM 3030 ultrasonic flowmeter is a precision instrument designed for linear, bi/directional flow measurement of liquids. Flow measurement values can be output via the standard analog and-or pulse/frequency outputs. Via a user friendly operator interface (HMI) the unit can be set up for a wide range of applications. Next to actual volumetric flow measurement the unit can be configured to perform flow totalization (plus, minus and sum). Also measurement and output of the liquid sonic velocity can be configured. Optionally the unit can be set to perform one of the following additional functions:

- Calculate and output corrected standard volumetric or mass flow using the external pressure and temperature inputs
- Batching
- Heat measurement

---

## 1.4 CE Approvals

**EMC, Electromagnetic Compatibility Directive**  
EMC directive 89/336/EEC.

### Low Voltage Directive

73/23/EEC and is designed in accordance with EN IEC 61010-1 first and second edition.

**Pressure Equipment Directive 97/23/EC / Module H**



---

## 2 Mechanical Installation

### 2.1 Handling the flowmeter

Important: Do not lift the compact flowmeter by the signal converter housing or the terminal box. Check the weight of the flowmeter as indicated on the type plate before handling the unit. When handling the flowmeter avoid hard blows, jolts or impacts.

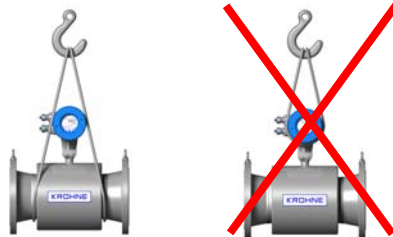

Do not place the flowmeter on the signal converter housing.



### 2.2 Installation location and position



If required the position of the signal converter can be modified by turning the display through 90° or 180°

Keep measuring tube completely filled at all times for proper flow measurement. Non-wetted sensors

show loss of signal. There is no damage when this occurs.

Flow direction. The UFM 3030 is a bi-directional flowmeter. Note the indicating arrow for the positive direction on the flowmeter.

In case of direct sunlight, we recommend installation of a sunshield to prolong the life of the meter. No direct damage will occur without a sunshield.

Do not expose the signal converter to excessive vibration. For this, support the pipeline on either side of the flowmeter.

To achieve the specified accuracy, ensure a straight inlet section of  $10 \times \text{DN}$  (DN = meter size) and an outlet section of  $5 \times \text{DN}$ .

Mixing different fluid products. Install the flowmeter upstream of mixing point or at minimum distance of  $30 \times \text{DN}$  (DN = meter size) downstream of the mixing point, otherwise the flow measurement may be unstable.

Ambient temperature all flowmeters:	-40 to +65°C/ -40 to +149°F
Product temperature compact flowmeter:	-25 to +140°C/ -13 F to +284°F
Product temperature separate flowmeter:	-25 to +180°C/ -13 to +356°F

a minimum distance between pipe centreline and any adjacent wall of at least 0.5 m (1.6 ft).

## 2.3 Special installation requirements

To avoid measuring errors and malfunctioning of the flowmeter due to gas or air inclusions or an empty pipe, please observe the following precautions:

Since gas will collect at the highest point of a pipe, installation of the flowmeter at that location should be avoided at all times. Also installation in a down going pipe should be avoided since a completely filled pipe may not be guaranteed due to cascading affects. Additionally flow profile distortion is possible.

Long horizontal pipes:  
install in slightly ascending pipe section. If not possible, ensure adequate velocity to prevent air, gas or vapour from collecting in upper part of flow tube As a partially filled meter will report higher than actual flow rates, or not measure (as transducer pairs become non-wetted).



Open feed or discharge:  
Install meter in a lowered section of the pipe to ensure a full pipe condition through the meter.



Down going pipeline over 5 m (16 ft) length:  
install air vent downstream of the flowmeter to prevent vacuum. While this will not harm the meter, it may cause gases to come out of solution (cavitate) and interfere with proper measurements.

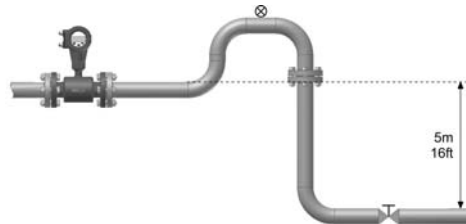

Always install control valves downstream of flowmeter in order to avoid cavitation or distortion of flow profile.

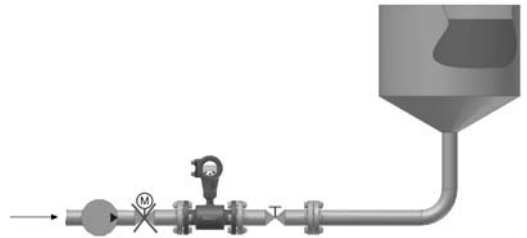

Never install flowmeter on a pump suction side in order to avoid cavitation or flashing in the flowmeter.



## 2.4 Pipe flanges

Refer to dimensional drawings for flange spacing and in addition allow for thickness of gaskets. Install flowmeter in line with pipe axis. Pipe flange faces must be parallel to each other, max. Permissible deviation:  $L_{max} - L_{min} \leq 0.5 \text{ mm}$  (0.02").

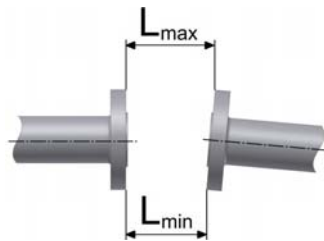

## 2.5 Pipes with cathodic protection

Pipes with electric corrosion protection are generally insulated inside and outside so that the fluid has no conductive connection to ground. The flowmeter must be insulated from the pipe. Note the following when installing the flowmeter:

The pipe flanges must be connected to each other using a copper cable (L), but must not be connected to the flowmeter.

The bolts for the flange connections and the gaskets must be insulated. Use sleeves and washers that are made of insulating material (these must be provided by customer).

1. Flange of flow sensor
2. Pipe flange
3. Gasket
4. Bolt
5. Nut
6. Washer
7. Insulating sleeve

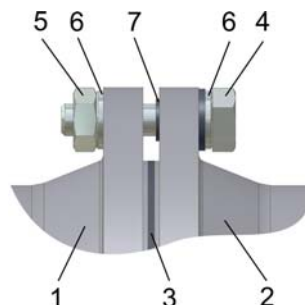

Follow grounding instructions.  
Use  $\geq 4 \text{ mm}^2$  ( $\geq \text{AWG } 10$  cable).  
Note: No earthing cables are supplied by KROHNE.

---

## 3 Connecting the signal converter

---

### 3.1 Safety instructions

This product is designed for use in accordance with EN IEC 61010-1 for Installation Category 2 and Pollution Degree 2. Hazardous voltages are present within this product during normal operation. The product is designed for Protection Class I and should never be operated without protective earthing. The product shall also never be operated with covers removed unless equivalent protection of the operator and its environment from accidental contact with hazardous internal voltages is provided. Always follow basic and local safety precautions when using this product to reduce risk of injury from electrical shock, spread of fire or other dangerous situations.

### 3.2 Converter terminal box

- The converter terminal box is accessible after removing the rear (blind) cover of the electronics section using the special wrench supplied with the flowmeter.
- Do not damage the screw thread and the gasket, never allow dirt to accumulate, and make sure that the screw thread is well greased, using Teflon grease at all times. A damaged gasket must be replaced immediately!
- Do not cross or loop the cables in the terminal box of the signal converter. Use separate cable entries for power supply and signal cables.
- Special regulations apply to installation in hazardous areas (see installation instructions for hazardous areas).

### 3.3 Power supply connection

In case of connection to the mains supply voltage:

Environmental conditions

- The UFM3030 is designed to operate safe under the following conditions:
- Suitable for indoor and outdoor use, the instrument is usable up to protection category IP67 (IEC 60529)
- Use up to an altitude of 2000 m above sea level
- Suitable for an operation ambient temperature range - 40 to +65°C
- Suitable for an storage temperature range -40 to + 80°C
- Suitable for use in atmospheres with a relative humidity up to 80%
- Over voltages up to category II on the main supply voltage ( IEC 60364-4-443)
- Connected to protective earth conductor ( Protection Class I)
- Rated pollution degree 2



- This instrument is intended for permanent connection to the mains. It is required (for example for service) to mount an external switch or circuit breaker near the product for disconnection from the mains. It must be easily reachable by the operator and marked as the disconnecting device for this product. The switch or circuit breaker has to be suitable for the application and shall also be in accordance with to local (safety) requirements and of the building installation. (IEC 60947-1/-3).
- The protective conductor clamp terminal size M5, press-fitted in the terminal compartment (near the main connection terminals), shall always to be connected to the protective earth conductor of the mains supply. Conductors up to 4 mm<sup>2</sup> (11 AWG) be connected to this terminal. The diameter of the conductors of the mains supply, including the protective earth conductor shall be in accordance with



the general and local requirements.

- It is not allowed to use the protective conductor terminal for any other connection than the protective earth conductor.
- IP 67 is only warranted when using suitable cabling with the cable glands and covers mounted as specified.

The power supply terminals has three connections

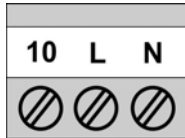

There is a separate earthing that must be connected:

Terminal	Function
10	Reserved Ground connection
L / L1	Live power supply

**Specification**  
 Not for protective earthing  
 Mains voltage AC supply:  
 100 V AC < U < 240 V AC: -15%, +10%  
 SELV AC/DC supply:  
 DC: 18-32 V dc  
 AC: 24 V AC: -10% +15%

N / N1 Neutral power supply



PE: Protective ground connection  
 FE: Functional ground connection

Protective conductor clamp terminal.  
 Conductors up to 4 mm<sup>2</sup> (11 AWG) need to be connected to this terminal.

### 3.4 Connection of sensor cables (UFM 3030F only)

For the UFM 3030 F the sensors must be connected using the factory supplied MR06 cable between the flow sensor terminal box and the converter housing terminal box. For the UFM 3030C this is connected at the factory.

Both the flow sensor terminals and the converter sensor terminals should be connected between the appropriate numbers indicated on the sensor cable and in the terminal boxes

Cable diameter: 11 mm (0,433 inch), minimum bending radius: 8 x cable diameter.

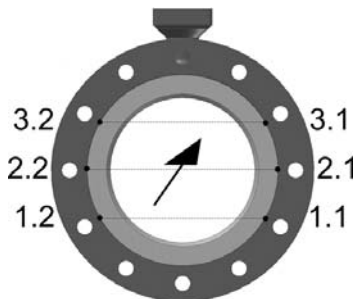

### 3.5 Electrical connection of the signal inputs and outputs

The terminal to connect the electrical signal inputs and outputs consist of 6 connections.

For standard instruments

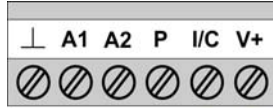

For instruments with a communication module

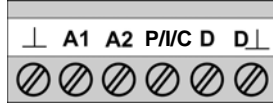

For wiring of the signal inputs and outputs it is advised to use unshielded twisted pairs.

Internal circuit of the signal inputs and outputs of the converter

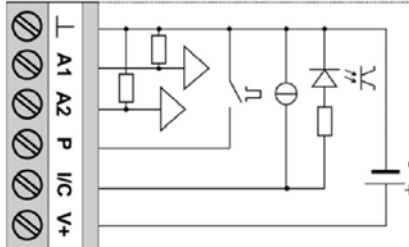

Terminal	Function	Specification
⊥	Common ground	-
A1	Analog input 1, for temperature measurement. Configuration via menu option 3.2.2. and 3.2.3.	0(4) to 20 mA Ri = 58,2 ohm, fuse: 50 mA
A2	Analog input 2, for temperature or pressure measurement. Configuration via menu option 3.2.4. and 3.2.5.	0(4) to 20 mA Ri = 58,2 ohm, fuse: 50 mA
P	Pulse/frequency output. Function can be set via menu option 3.5.0.	I max: 150 mA Umax: 32Vdc, 24Vac Max frequency: 2 kHz
I/C	Combined Current output (I) and Digital input (C). Current output (I) Incl. Hart communication Function can be set via menu option 3.4.0. and 3.6.0.	Current output (I): I ≤ 22 mA, Rload ≤ 680 ohm. Umax = 15Vdc. Digital input (C): low = 0-5 VDC, high = 15-32 VDC. Will be switched off when current output activated.
V+	DC power supply from converter for active wiring of inputs and outputs	22 VDC at full load, 24 VDC maximum. I ≤ 100 mA.
D+	Communication connection+	For fieldbus communication
D-	Communication connection -	For fieldbus communication
P/I/C	Combined current output (I) digital output (C) and pulse output (P). See individual I/C terminal and P terminal functions	See individual I/C terminal and P terminal specifications.

The electrical input and output signals can be connected either in active or in passive mode. In active mode DC supply voltage is provided from the V+ terminal. In passive mode supply voltage is provided from an external source. Please observe instrument polarity: current (I) is always flowing towards I, C, P, A1, A2 terminals (current sink).

Note! Never use the active and passive mode at the same terminal simultaneously.

If HART communication is used, do not connect the pulse/frequency output P in active mode.

### 3.6 Connection diagram examples

#### Current output

Active

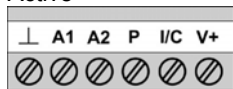

$R_i \leq 680 \text{ ohm}$

Passive

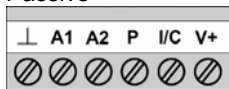

For supply:  
 $U = 15 \dots 24 \text{Vdc}$ ,  $I \geq 22 \text{mA}$

#### Pulse output

Active

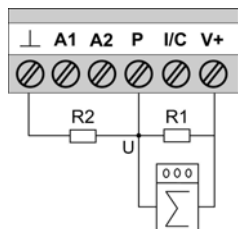
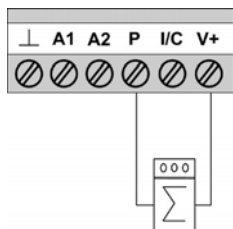

$R_1 \geq 470 \text{ ohm}$ ,  
 $R_2 = U \cdot R_1 / (V_+ - U)$

Passive

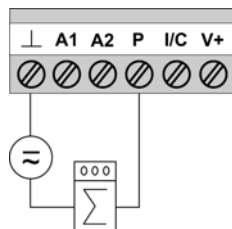

For supply:  $U \leq 32 \text{Vdc}$ ,  $\leq 24 \text{Vac}$

#### Digital input

Active

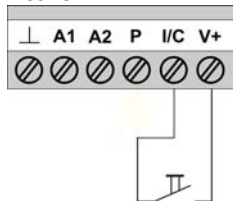

Passive

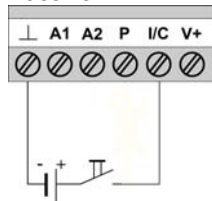

For supply:  $U = 15 - 30 \text{Vdc}$ ,  $I \geq 1,5 \text{ mA}$

#### Analog input

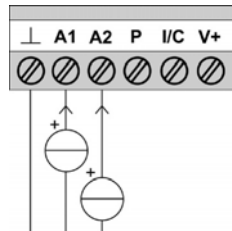

## 4 Start-up

- Check that the flowmeter has been correctly installed.
- With separate systems, check before initial start-up that the correct converter (UFC 030 F) is used with the correct flow sensor (UFS 3000).
- Order No., see instrument nameplates
- Meter size (DN), Function 3.1.5
- Primary constant GK, Function 3.1.6
- Flow direction, Function 3.1.7
- When powered, the signal converter operates in the measuring mode. TEST, NO ERROR and IDENT NO. \_\_\_\_\_ of the signal converter appear in succession on the display. This is followed by display of the actual flow rate and/or the internal count on a continuous or alternating basis (depending on setting, see Function 3.03 Display or Function 1.02 Display).

---

---

## Part B The signal converter

---

### 5 Operating the signal converter

---

#### 5.1 Front panel and operating keys

The front panel and its operating keys are accessible after removing the front (glass) cover of the electronics section using the special wrench supplied with the flowmeter.



When removing the cover, do not damage the screw thread and the gasket, never allow dirt to accumulate, and make sure that they are well greased using Teflon grease at all times. A damaged gasket must be replaced immediately!



1. Display 1st (top) line, measured value
2. Display 2nd (middle) line, units of measured value
3. Display 3rd (bottom) line with markers ▼  
to identify actual displayed value, from left to right:  
Flow rate  
Velocity of Sound VOS  
Total + Totalizer (forward flow)  
Total - Totalizer (reverse flow)  
Total  $\Sigma$  Totalizer sum (+ and -)
4. Compass field for error indication
5. Operating keys for programming the signal converter
6. Magnetic sensors to program the signal converter by means of a hand-held bar magnet (optional) without having to open the housing

The function of the sensors is as follows: the left most sensor is equivalent to left key, the right most, the right key, and the top, the center key.

The converter can display several types of measured values (depending on the programming), indicated by the markers at the display bottom line. They can be selected manually at any time by pressing the  $\uparrow$  key or they are automatically cycled at 5 second intervals. Errors are indicated by flashing display lines and/or by the compass field. For a description of the errors and what to do, see main menu Error/Totalizer.

---

## 5.2 Menu structure and function of operating keys

The menu structure consists of user accessible blocks.

- Function block 0 Error/Totalizer reset can be accessed from the measuring mode and provides detailed information on errors occurred during operation. It allows for fast and easy resetting of the errors and Totalizers.
- Function block 1 Operation contains a subset of options from function block 3, Installation. The options in function block 1 are selected so that the most commonly used functions can be selected quickly from this menu. In most cases only function block 1 needs to be accessed in order to perform the required setting or programming task.
- Function block 2 Test contains all available test functions. This block can be accessed to check proper functioning of all converter hard- and software.
- Function block 3 Installation contains all other set-up parameters for the converter. In general the converter is factory-preset. See Service Handbook for modification instructions.
- Function block 4 Parameter Error becomes active automatically when non-plausible values have been programmed, e.g. a too high a flow rate in too small a diameter. If this is the case menu 4 will indicate that either FULL SCALE or METER SIZE needs to be changed.

The figure below shows the main operation structure of the converter. The cursor or flashing part of the display is shown as underlined text. For a complete overview of the menu see the Service Handbook.

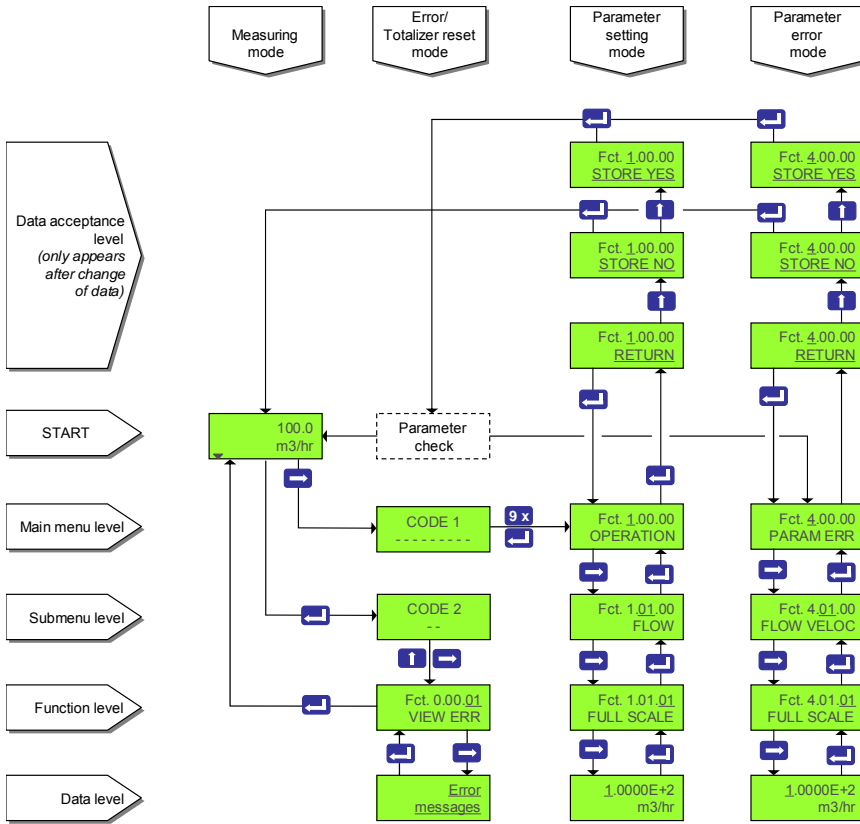

Key	Measuring mode	Menu mode	Data level
→	Go to the parameter setting mode, function 1.00.00 OPERATION. If access CODE 1 is activated, CODE 1 must be entered first. Using function 3.07.02 access CODE 1 can be activated or deactivated.	Go to the next, lower menu level.	Go to the next character or change line (only when 2 lines are displayed)
↵	Go to the error/Totalizer reset mode (via "CODE 2")	Return to the previous (higher) menu level or leave the menu mode.	Accept entered value
↑	Cycle through measured values, see Function 3.03.07 CYCL DISP	Cycle through menu options within actual menu level.	Cycle active digit up to new values

Function	Text	Description and settings
0.00.00	ERROR/TOT	Main menu 0.00.00 Error/Totalizer
0.00.01	VIEW ERR	View error messages list
0.00.02	RST ERR	Reset error messages
		NO RESET (keep error messages list) RESET (reset error messages list)
0.00.03	RST TOTAL	Reset Totalizer (option available depending on setting in 3.7.8) RESET ALL (reset all Totalizer values) NO RESET (keep Totalizer values)

1.00.00	OPERATION	Main menu 1.00.00 Operation
1.01.00	FLOW	Submenu 1.01.00 Flow
1.01.01	FULL SCALE	Full-scale value for 100% volume flow rate, see Function 3.01.01
1.01.02	ZERO VALUE	Zero value, see Function 3.01.02
1.01.03	ZERO CAL	Zero calibration, see Function 3.01.03
1.01.04	MASTER TC	Master time constant, see Function 3.01.04
1.01.05	LF CUTOFF	Low-flow cut-off, see Function 3.01.05
1.01.06	CUTOFF ON	Cut-off active, see Function 3.01.06
1.01.07	CUTOFF OFF	Cut-off de-active, see Function 3.01.07
1.02.00	DISPLAY	Submenu 1.02.00 Display
1.02.01	DISP FLOW	Display of flow, see Function 3.03.01
1.02.02	DISP TOTAL	Function of Totalizer, see Function 3.03.02
1.02.03	TOTAL VOL	Display of Totalizer, see Function 3.03.04
1.03.00	PULSE OUTP	Submenu 1.03.00 Pulse output
1.03.01	PULSE RATE	Pulse frequency value for 100 % scale, See Function 3.05.08
1.03.02	PULSE/UNIT	Pulse value per volume flow unit, see Function 3.05.09
1.03.03	PULSE/UNIT	Pulse value per energy unit, see function 3.05.10

2.00.00	TEST	Main menu 2.00.00 Test functions
2.01.00	DISPLAY	Submenu 2.01.00 Display
2.01.01	DISPLAY	Test display, lights all pixels. End with ↵ key
2.02.00	OUTPUTS	Submenu 2.02.00 Outputs
2.02.01	CURRENT	Test current output 0 mA      4 mA 12 mA     20 mA 22 mA Use up arrow to advance. Displayed value directly present at current output. Actual value present at output after pressing ↵ key.
2.02.02	PULSE	Test pulse/frequency output 1 Hz      10 Hz 100 Hz    1000 Hz 2000 Hz Use the up arrow to advance. Displayed value directly present at pulse output. Actual value present at output after pressing ↵ key
2.03.00	INPUTS	Submenu 2.03.00 Inputs
2.03.01	AN INP 1	Test analog input 1 Measure current at analog input 1. End with ↵ key.
2.03.02	AN INP 2	Test analog input 2 Measure current at analog input 2. End with ↵ key.
2.03.03	DIG INPUT	Test digital input Measure level at digital input. End with ↵ key.
2.03.04	SENSOR	Sensor status, per sensor (6 statuses in total): good, open, short

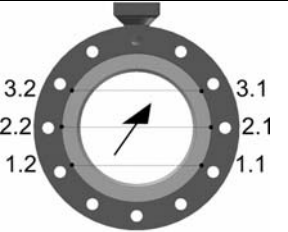
		<p>Sensor coding:  X.X = path.sensor  Path 1 = lower path, path 2 = middle path, path 3 = upper path.  X.1: upstream sensor  X.2: down stream sensor</p>
2.04.00	DEV INFO	Submenu 2.04.00 Device information
2.04.01	MANUFACT	Display manufacturer
2.04.02	MODEL NO	Display model number
2.04.03	SERIAL NO	Display serial number
2.04.04	UP2 HW NO	Display $\mu$ P2 hardware number
2.04.05	UP2 SW NO	Display $\mu$ P2 software number
2.04.06	FRNT HW NO	Display front end hardware number
2.04.07	DSP HW NO	Display D.S.P. hardware number
2.04.08	DSP SW NO	Display D.S.P. software number
2.04.09	TIME COUNT	Display time counter

3.00.00	INSTALL	Main menu 3.00.00 Installation
3.01.00	FLOW	Submenu 3.01.00 Volume flow parameters
3.01.01	FULL SCALE	Full-scale value for 100% volume and flow rate units (see Function 1.01.01). The selection of units may be limited to SI units only. m <sup>3</sup> /s, m <sup>3</sup> /min, m <sup>3</sup> /hr, L/s, L/min, L/hr, US.Gal/s, US.Gal/min, US.Gal/hr, bbls/hr, bbls/day, ***** (free user configurable unit).
3.01.02	ZERO VALUE	Zero value (see Function 1.01.02) FIXED (factory zero setting) MEASURED (zero calibration possible, see Function 3.01.03)
3.01.03	ZERO CAL	Zero calibration (see Function 1.01.03) Carry out only at "zero" flow and with completely filled measuring tube. Duration approximately 15s with display indicating "BUSY". STORE NO (preserve old zero value) STORE YES (store new zero value)
3.01.04	MASTER TC	Master time constant of display and current output (see Function 1.01.04) Range: 0.02 through 99.99 s
3.01.05	LF CUTOFF	Low-flow cut-off for display and outputs (see 1.01.05) NO (fixed tripping points: ON = 0.1%, OFF = 0.2%) YES (see Function 3.01.06 and 3.01.07)
3.01.06	CUTOFF ON	Cut off "active" value Range: 1 through 19% of Q100%
3.01.07	CUTOFF OFF	Cut off "de-active" value Range: 2 through 20% of Q100% Value "off" must be greater than value "on"
3.01.08	METER SIZE	Meter size Selection of size from meter size table: 25-3000 mm equivalent to 1-120 inch
3.01.09	GK VALUE	Flow sensor constant (GK) Must equal flow sensor nameplate value Range: 0.02 through 20



3.01.10	FLOW DIR	Definition of forward flow direction POSITIVE NEGATIVE Setting in accordance with direction of arrow on flow sensor
3.01.11	MIN VOS	Minimum velocity of sound (VOS) Value used for I0% or P0% when function "VOS" selected in Function 3.04.01 or 3.05.01 Unit: m/s or feet/s Range: 0 through 4999 m/s (0 through 15000 feet/s)
3.01.12	MAX VOS	Maximum velocity of sound Value used for I100% or P100% when function "VOS" selected in Function 3.04.01 or 3.05.01 Unit: m/s or feet/s Range: 1 through 4999 m/s (0 through 15000 feet/s) Maximum value must be greater than minimum value
3.02.00	VERSION	Submenu 3.02.00 Version
3.02.01	FUNCTION	Function of converter This is factory pre-set and can only be changed to standard from any setting. MODIS setting can not be altered. STANDARD CORR T (temperature correction via input 1, see also Function 3.02.08 through 3.02.11) CORR T+ P (temperature correction via input 1, pressure correction via input 2, see also Function 3.02.08 through 3.02.11) HEAT (heat measurement, see function 3.02.12) BATCH (batch volume, see Function 3.02.13) MODIS
3.02.02	INP1 4 mA	4 mA Reference for analog input 1 4 mA Temperature reference Unit: Celsius or Fahrenheit Range: -50° through 150°C
3.02.03	INP1 20 mA	20 mA Reference for analog input 1 20 mA Temperature reference Unit: Celsius or Fahrenheit Range: -50° through 150°C
3.02.04	INP2 4 mA	4 mA Reference for analog input 2 4 mA Temperature reference Unit: Celsius or Fahrenheit Range: -50° through 150°C
3.02.05	INP2 20 mA	20 mA Reference for analog input 2 20 mA Temperature reference Unit: Celsius or Fahrenheit Range: -50° through 150°C
3.02.06	INP2 4 mA	4 mA Reference for analog input 2 4 mA Pressure reference Unit: bar(a) or psi(a) Range: 0 through 100 Bar(a)
3.02.07	INP2 20 mA	20 mA Reference for analog input 2 20 mA Pressure reference Unit: bar(a) or psi(a) Range: 0 through 100 Bar(a)
3.02.08	K0	Product constant K0 Range: 10 <sup>-9</sup> through 10 <sup>9</sup>

3.02.09	K1	Product constant K1 Range: : 10-9 through 109
3.02.10	K2	Product constant K2 Range: : 10-9 through 109
3.02.11	DENSITY 15	Product density at T = 15°C Range: 500 through 2000 kg/m <sup>3</sup>
3.02.12	FULL SCALE	Heat measurement Full scale setting and unit for Heat power. GJ/s, GJ/hr, MJ/s, MJ/hr, GCal/s, GCal/hr, MCal/s, MCal/hr
3.02.13	BATCH VOL	Batch volume Total size and units. m <sup>3</sup> , Liter, US.Gallon, Barrel or user definable unit Range: 0.025 through 100000 m <sup>3</sup>
3.03.00	DISPLAY	Submenu 3.03.00 Display (see Function 1.02.01)
3.03.01	DISP FLOW	Display of flow RATE (full-scale units) Percent (percentage of full-scale, 0% - 100%) NO DISPLAY (no flow display)
3.03.02	FUNCT TOT	Function of Totalizer ACT FLOW (actual flow units) CORR FLOW (corrected flow units) POS BOTH (both, only forward)
3.03.03	DISP TOTAL	Display of Totalizer (see Function 1.02.02) A Totalizer can be selected here for displaying. Available options are TOTAL OFF, FORWARD, REVERSE, BOTH, SUM, BOTH + SUM, NO DISPLAY
3.03.04	TOTAL VOL	Unit for volume Totalizer X10 m <sup>3</sup> , US.Gallon, m <sup>3</sup> , Barrel, liter
3.03.05	TOTAL ENER	Unit for energy Totalizer X 10 GJ, GJ, MJ, GCal, MCal
3.03.06	VOS	Unit for Velocity Of Sound NO DISPLAY, m/s, feet/s
3.03.07	CYCL DISP	Cyclic display of measured values NO, YES
3.03.08	ERROR MSG	Display error messages NO, YES
3.03.09	DATE	Display date NO, YES
3.03.10	AN INPUT	Display analog inputs NO, YES
3.03.11	SIGN LEVEL	Display signal level NO, YES
3.04.00	CURR OUTP	Submenu 3.04.00 Current output
3.04.01	FUNCTION	Function of current output OFF (switched off) ACT FLOW (actual flow) CORR FLOW (corrected flow), see Function 3.02.02 and 3.02.08 through 3.02.11 F/R IND (forward/reverse indication of actual flow) VOS (velocity of sound, range is defined in Function 3.01.11 and 3.01.12) GAIN (sensor signal gain, range is 0 dBV through 100 dBV) AN INP 1 (analog input 1) AN INP 2 (analog input 2)

3.04.02	DIRECTION	Direction of current output FORWARD (forward flow measurement) BOTH (forward and reverse flow measurement indicating both in the same range) F/R SPEC (forward and reverse flow measurement indicated in different range see Function 3.04.04)
3.04.03	RANGE	Range of current output OTHER (user defined, see Function 3.04.04 through 3.04.06) 0-20/22 mA (0 pct - 100 pct / limit) 4-20/22 mA(0 pct - 100 pct / limit)
3.04.04	0 pct	Current value for 0% scale Range: 0 through 16 mA
3.04.05	100 pct	Current value for 100% scale Range: 4 through 20 mA Value must be at least 4 mA greater than current value for 0% scale
3.04.06	LIMIT	Limitation of current value Range: 20 through 22 mA
3.04.07	ERR INDIC	IERR = 3.6 MA IERR = 21.5 MA (only available for NAMUR devices)
3.05.00	PULSE OUTP	Submenu 3.05.00 Pulse output
3.05.01	FUNCTION	Function of pulse output OFF (switched off) ACT FLOW (actual flow) CORR FLOW (corrected flow), see Function 3.02.01 and 3.02.08 through 3.02.11 F/R IND (forward/reverse flow indication) VOS (velocity of sound, range defined in Function 3.01.11 and 3.01.12) DIG OUTPUT (digital output, see Function 3.05.03) BATCH OUTP (batch output indication, see Function 3.02.01) GAIN (sensor signal gain, range is 0 dBV through 100 dBV) AN INP 1 (analog input 1) AN INP 2 (analog input 2)
3.05.02	DIRECTION	Direction of pulse output FORWARD (forward flow measurement) BOTH (forward and reverse flow measurement indicating both in the same range)
3.05.03	DIG OUTPUT	Function of digital output PATH ERR (measuring path error indication) TOTAL ERR (Totalizer error indication) ALL ERR (indication of all errors) AN INP ERR (analog input error indication) OVERRANGE (overrange indication) TRIP POINT (trips when actual flow (Q) goes over a set limit)
3.05.04	TRIP PNT 1	First trip point Range: 0 through 120% of Q100%
3.05.05	TRIP PNT 2	Second trip point Range: 0 through 120 % of Q100%
3.05.06	TIME CONST	Time constant of pulse output 25 ms MASTER TC (see Function 3.01.04)
3.05.07	OUTPUT	Unit of pulse output (see Function 1.03.00) PULSE FREQUENCY, pulses per unit time, see Function 3.05.08) PULSE/UNIT, Totalizer pulse output, pulses per unit volume, see

		Function 3.05.09
3.05.08	PULSE RATE	Pulse rate (frequency) value for 100 % scale pulse/s, pulse/hr, pulse/min Range: 1 pulse/hr through 2000 pulse/s
3.05.09	PULSE/UNIT	Pulse value per volume unit for totalisation pulse/m <sup>3</sup> , pulse/l, pulse/US.Gal, pulse/bbl, free user definable unit
3.05.10	PULSE/UNIT	Pulse value per heat energy unit for totalisation Pulse/MJ, pulse/Gcal, pulse/Mcal, pulse/GJ
3.05.11	PULS WIDTH	Pulse width for frequencies ≤ 10 Hz 25 ms, 50 ms, 100 ms, 200 ms, 500 ms
3.06.00	DIG INPUT	Submenu 3.06.00 Digital input
3.06.01	FUNCTION	Function of digital input OFF (switched off) RST TOTAL (reset display Totalizer) RST ERROR (reset error messages) FORCE ZERO (set outputs to minimum values) BATCH (start batch)
3.07.00	USER DATA	Submenu 3.07.00 User data
3.07.01	LANGUAGE	Language for display texts GB/USA (English) D (German) F (French)
3.07.02	ENTRY CODE	Entry code for setting mode NO (entry with key only) YES (entry with key and code 1, factory set on 9 x key, see Function 3.07.03)
3.07.03	CODE 1	Code 1 Press any 9-keystroke combination and then press the same combination again. Each keystroke is acknowledged by "Ж" in the display. If both combinations are equal, "CODE OK" appears and the new code can be stored, else "WRONG CODE" appears and the desired code has to be entered again.
3.07.04	LOCATION	Tag name setting Free settable tag for identification, maximum 10 characters. Characters assignable to each place: A..Z / blank character / 0..9 Factory setting: KROHNE
3.07.05	UNIT TEXT	Text for user-defined unit Definition: volume/time Characters assignable to each place: A..Z / blank character / 0..9 Fraction bar "/" in 5th place is unalterable Factory setting: XXXX/YYYY
3.07.06	UNIT VOL	User-defined unit volume Quantity of user-defined volume per m <sup>3</sup> . Range: 10-5 through 107 Factory setting: 1
3.07.07	UNIT TIME	User-defined unit time Amount of user-defined time in seconds Range: 10-5 through 107 Factory setting: 1
3.07.08	RST ENABLE	Enable Totalizer reset NO (Totalizer reset disabled) YES (Totalizer reset enabled)

3.07.09	ERR LIMIT	Error limit in % of measured value for plausibility filter on the sensor paths.
3.07.10	CNT DECR	Counter decrement setting for plausibility filter
3.07.11	CNT LIMIT	Counter limit for plausibility filter When "0" is set, the plausibility filter will become inactive Range: 0 through 1000 Factory setting: 0
3.09.00	COMMUNIC	Submenu 3.09.00 Communication
3.09.01	PROTOCOL	Communication protocol OFF (no communication) HART (HART) PROFIB PA (PROFIBUS PA)
3.09.02	HART ADDR	HART address Range: 00 through 16
3.09.03	PP/FF ADDR	PROFIBUS PA/FOUNDATION Fieldbus address Range: 000 through 126

4.00.00	PARAM ERR	Main menu 4.00.00 Parameter error
4.01.00	FLOW VELOC	Volume flow velocity (v) value incorrect. The flow speed is calculated from the full scale volume flow and the meter size. Ensure condition $0.5 \text{ m/s} \leq v \leq 20 \text{ m/s}$ (1,5 to 66 feet/s) is met!
4.01.01	FULL SCALE	Full-scale value for 100% volume flow rate, see Function 3.01.01
4.01.02	METER SIZE	Meter size, see Function 3.01.08
4.02.00	CURR OUTP	Current output range incorrect. Setting for 100% is compared with setting for 0%. Ensure condition $100 \text{ pct} - 0 \text{ pct} \geq 4 \text{ mA}$ is met!
4.02.01	RANGE	Range of current output, see Function 3.04.03
4.02.02	0 pct	Current value for 0% scale, see Function 3.04.04
4.02.03	100 pct	Current value for 100% scale, see Function 3.04.05
4.03.00	LF CUTOFF	Low-flow cut-off range incorrect: If low flow cut-off is set to on, the value for CUTOFF-OFF is compared with the value of CUTOFF-ON on. Ensure condition $\text{CUTOFF-OFF} - \text{CUTOFF-ON} \geq 1\%$ is met!
4.03.01	LF CUTOFF	Low-flow cut-off, see Function 3.01.05
4.03.02	CUTOFF ON	Cutoff "on" value, see Function 3.01.06
4.03.03	CUTOFF OFF	Cutoff "off" value, see Function 3.01.07
4.04.00	ENERGY	Full scale value for heat energy rate (E) incorrect. The fullscale value is compared with the maximum value that can be measured and should meet the condition: $E_{\text{max}} < E_{\text{fullscale}} < E_{\text{max}}/1000$ The maximum value that can be measured is at maximum flow and 200° C temperature difference.
4.04.01	HEAT FS	Full-scale value for 100 % heat energy rate, see Function 3.02.12
4.05.00	PULSE/VOS	Unit of pulse output for velocity of sound function incorrect Ensure "PULSE RATE" is selected for "VOS"!
4.05.01	PULS FUNCT	Function of pulse output, see Function 3.05.01
4.05.02	PULSE OUTP	Unit of pulse output, see Function 3.05.07
4.06.00	VOS	Velocity of sound range incorrect: Ensure condition $\text{MAX VOS} - \text{MIN VOS} \geq 1 \text{ m/s}$ (3.3 feet/sec) is met!
4.06.01	MIN VOS	Minimum velocity of sound, see Function 3.01.11
4.06.02	MAX VOS	Maximum velocity of sound, see Function 3.01.12
4.07.00	PULSE OUTP	Pulse output frequency value (f) incorrect. The max frequency is calculated from the pulse/unit setting and the max value of the measured value. Ensure condition $1 \text{ pulse/hr} \leq f \leq 2000 \text{ pulse/s}$ is met.

4.07.01	PULSE/UNIT	Pulse value for volume flow rate unit, see Function 3.05.09
4.07.02	PULSE/UNIT	Pulse value for heat power rate unit, see Function 3.05.10
4.08.00	PULS WIDTH	Pulse output pulse width incorrect Ensure condition pulse width $\leq 0.5 \times$ pulse period time is met.
4.08.01	PULS WIDTH	Pulse width for frequencies $\leq 10$ Hz, see Function 3.05.11
4.09.00	HART	Current output range for HART incorrect. If Hart is activated the minimum possible current should be 4 mA. Ensure condition CURR 0 pct $\geq 4$ mA is met.
4.09.01	CURR RANGE	Range of current output, see Function 3.04.03
4.09.02	CURR 0 pct	Current value for 0% scale, see Function 3.04.04
4.10.00	INP/OUTP	The digital input (C) and current output (I) are not allowed to be switched on simultaneously. If the Profibus option is activated only one of the following input/output functions can be used: digital input (C), current output (I), pulse output (P). The current output is deactivated by setting the function of current output to off en setting the range of current output to 0-20mA.
4.10.01	INP FUNCT	Function of digital input, see Function 3.06.01
4.10.02	CURR FUNCT	Function of current output, see Function 3.04.01
4.10.03	CURR RANGE	Range of current output, see Function 3.04.03
4.10.04	PULS FUNCT	Range of pulse output, see Function 3.05.01
4.13.00	EPROM	EPROM checksum error, reset device.

---

## 6 Service and Repair

---



By qualified personnel only. Refer to Service Handbook or call in your KROHNE authorised service engineer.

### 6.1 Returning the flowmeter to KROHNE for service or repair

KROHNE will only service your flowmeter if it is accompanied by a statement in line with the following model confirming that the flowmeter is safe to handle.

If the flowmeter has been operated with toxic, caustic, flammable or water polluting liquids, you are kindly requested:

- To check and ensure, if necessary by rinsing or neutralising, that all cavities in the flowmeter are free from dangerous substances.
- To enclose a statement with the flowmeter confirming that the flowmeter is safe to handle and stating the liquid used. KROHNE regrets that they can not service your flowmeter unless accompanied with such a statement.

**The following specimen statement is available on the KROHNE website as a word file. Simply download and use the tabulator key to go from one fill-out field to the next. Please attach the form to the returned meter.**

#### Specimen statement:

Company:  Department:   
Address:   
Name:  Tel. No.

Details enclosed flowmeter:

Type:   
KROHNE Order No.

Has been operated with the following liquid:

Because the liquid is:

water-pollutant  toxic  caustic  flammable (tick where applicable)

We have checked that the flowmeter and all cavities in the flowmeter are

free from such substances  flushed\* out and  neutralised (tick where applicable).

We hereby confirm that there is no risk to man or environment through any residual liquid in or on the flowmeter or in any of its cavities.

Date:   
Signature: \_\_\_\_\_

Place: \_\_\_\_\_  
Company Stamp: \_\_\_\_\_