



SMARTPAT ORP 8510 Handbook

Digital ORP sensor for the water industry

All rights reserved. It is prohibited to reproduce this documentation, or any part thereof, without the prior written authorisation of KROHNE Messtechnik GmbH.

Subject to change without notice.

Copyright 2016 by
KROHNE Messtechnik GmbH - Ludwig-Krohne-Str. 5 - 47058 Duisburg (Germany)

1	Safety instructions	5
1.1	Software History	5
1.2	Intended use	6
1.3	Certifications	6
1.4	Safety instructions from the manufacturer	7
1.4.1	Copyright and data protection	7
1.4.2	Disclaimer	7
1.4.3	Product liability and warranty	8
1.4.4	Information concerning the documentation	8
1.4.5	Warnings and symbols used	9
1.5	Safety instructions for the operator	9
2	Device description	10
2.1	Scope of delivery	10
2.2	Device description	11
2.2.1	Device description	11
2.3	Nameplate	12
3	Installation	13
3.1	General notes on installation	13
3.2	Storage and transport	14
3.3	Pre-installation requirements	14
3.4	Installation procedure	15
4	Electrical connections	16
4.1	Safety instructions	16
4.2	Power supply	16
4.3	Grounding and equipotential bonding	17
4.4	Connecting the cable to the sensor	17
4.5	Connecting the sensor cable	18
4.6	Connection diagram	18
4.7	Installing the sensor	20
4.7.1	General installation instructions	20
4.7.2	General installation instructions	21
4.7.3	Installation steps	22
5	Operation	23
5.1	Calibration	23
5.1.1	Calibration with PACTware™	23
5.1.2	Calibration with HART® Handheld 475 FIELD COMMUNICATOR	24
5.2	Troubleshooting	25
5.3	Status messages and diagnostic information	26

6 Service	27
6.1 Maintenance	27
6.1.1 Cleaning	27
6.1.2 Aging and re-calibration	27
6.2 Availability of services	27
6.3 Returning the device to the manufacturer	28
6.3.1 General information	28
6.3.2 Form (for copying) to accompany a returned device	29
6.4 Disposal	29
7 Technical data	30
7.1 Measuring principle	30
7.1.1 ORP measurement	30
7.2 Technical data	31
7.3 Dimensions	33
8 Description of HART interface	34
8.1 General description	34
8.2 Software history	34
8.3 Connection variants	35
8.3.1 Point-to-Point connection - analogue / digital mode	36
8.4 Inputs/outputs and HART [®] dynamic variables and device variables	37
8.5 Field Communicator 475 (FC 475)	37
8.5.1 Installation	37
8.6 Field Device Tool / Device Type Manager (FDT/DTM)	38
8.6.1 Installation	38
8.7 Overview Basic-DD menu tree (positions in menu tree)	38
8.8 Basic-DD menu tree (details for settings)	39
9 Notes	42

1.1 Software History

The "Electronic Revision" (ER) is consulted to document the revision status of electronic equipment according to NE 53 for all GDC devices. It is easy to see from the ER whether troubleshooting or larger changes in the electronic equipment have taken place and how that has affected the compatibility.

Changes and effect on compatibility

1	Downwards compatible changes and fault repair with no effect on operation (e.g. spelling mistakes on display)	
2- _	Downwards compatible hardware and/or software change of interfaces:	
	H	HART®
	P	PROFIBUS
	F	Foundation Fieldbus
	M	Modbus
X	all interfaces	
3- _	Downwards compatible hardware and/or software change of inputs and outputs:	
	I	Current output
	F, P	Frequency / pulse output
	S	Status output
	C	control input
	CI	Current input
X	all inputs and outputs	
4	Downwards compatible changes with new functions	
5	Incompatible changes, i.e. electronic equipment must be changed.	



INFORMATION!

In the table below, "x" is a placeholder for possible multi-digit alphanumeric combinations, depending on the available version.

Release date	SW/HW version	Changes and compatibility	Documentation
2015-12-01	SW 1.0.x HW 1.0.x	-	MA SMARTPAT ORP 8510 R03

1.2 Intended use

**CAUTION!**

Responsibility for the use of the measuring devices with regard to suitability, intended use and corrosion resistance of the used materials against the measured fluid lies solely with the operator.

**INFORMATION!**

The manufacturer is not liable for any damage resulting from improper use or use for other than the intended purpose.

The intended use of SMARTPAT ORP 8510 sensor is the measurement of ORP value in water applications.

1.3 Certifications

CE marking



The device fulfils the statutory requirements of the following EC directives:

- EMC Directive 2004/108/EC (valid until 2016/04/19) or
EMC Directive 2014/30/EU (valid from 2016/04/20)

as well as

- NAMUR recommendation NE 21

The manufacturer certifies successful testing of the product by applying the CE marking.

1.4 Safety instructions from the manufacturer

1.4.1 Copyright and data protection

The contents of this document have been created with great care. Nevertheless, we provide no guarantee that the contents are correct, complete or up-to-date.

The contents and works in this document are subject to copyright. Contributions from third parties are identified as such. Reproduction, processing, dissemination and any type of use beyond what is permitted under copyright requires written authorisation from the respective author and/or the manufacturer.

The manufacturer tries always to observe the copyrights of others, and to draw on works created in-house or works in the public domain.

The collection of personal data (such as names, street addresses or e-mail addresses) in the manufacturer's documents is always on a voluntary basis whenever possible. Whenever feasible, it is always possible to make use of the offerings and services without providing any personal data.

We draw your attention to the fact that data transmission over the Internet (e.g. when communicating by e-mail) may involve gaps in security. It is not possible to protect such data completely against access by third parties.

We hereby expressly prohibit the use of the contact data published as part of our duty to publish an imprint for the purpose of sending us any advertising or informational materials that we have not expressly requested.

1.4.2 Disclaimer

The manufacturer will not be liable for any damage of any kind by using its product, including, but not limited to direct, indirect or incidental and consequential damages.

This disclaimer does not apply in case the manufacturer has acted on purpose or with gross negligence. In the event any applicable law does not allow such limitations on implied warranties or the exclusion of limitation of certain damages, you may, if such law applies to you, not be subject to some or all of the above disclaimer, exclusions or limitations.

Any product purchased from the manufacturer is warranted in accordance with the relevant product documentation and our Terms and Conditions of Sale.

The manufacturer reserves the right to alter the content of its documents, including this disclaimer in any way, at any time, for any reason, without prior notification, and will not be liable in any way for possible consequences of such changes.

1.4.3 Product liability and warranty

The operator shall bear responsibility for the suitability of the device for the specific purpose. The manufacturer accepts no liability for the consequences of misuse by the operator. Improper installation or operation of the devices (systems) will cause the warranty to be void. The respective "Standard Terms and Conditions" which form the basis for the sales contract shall also apply.

1.4.4 Information concerning the documentation

To prevent any injury to the user or damage to the device it is essential that you read the information in this document and observe applicable national standards, safety requirements and accident prevention regulations.

If this document is not in your native language and if you have any problems understanding the text, we advise you to contact your local office for assistance. The manufacturer can not accept responsibility for any damage or injury caused by misunderstanding of the information in this document.

This document is provided to help you establish operating conditions, which will permit safe and efficient use of this device. Special considerations and precautions are also described in the document, which appear in the form of icons as shown below.

1.4.5 Warnings and symbols used

Safety warnings are indicated by the following symbols.



DANGER!

This warning refers to the immediate danger when working with electricity.



DANGER!

This warning refers to the immediate danger of burns caused by heat or hot surfaces.



DANGER!

This warning refers to the immediate danger when using this device in a hazardous atmosphere.



DANGER!

These warnings must be observed without fail. Even partial disregard of this warning can lead to serious health problems and even death. There is also the risk of seriously damaging the device or parts of the operator's plant.



WARNING!

Disregarding this safety warning, even if only in part, poses the risk of serious health problems. There is also the risk of damaging the device or parts of the operator's plant.



CAUTION!

Disregarding these instructions can result in damage to the device or to parts of the operator's plant.



INFORMATION!

These instructions contain important information for the handling of the device.



LEGAL NOTICE!

This note contains information on statutory directives and standards.



• **HANDLING**

This symbol designates all instructions for actions to be carried out by the operator in the specified sequence.

➔ **RESULT**

This symbol refers to all important consequences of the previous actions.

1.5 Safety instructions for the operator



WARNING!

*In general, devices from the manufacturer may only be installed, commissioned, operated and maintained by properly trained and authorized personnel.
This document is provided to help you establish operating conditions, which will permit safe and efficient use of this device.*

2.1 Scope of delivery



INFORMATION!

Inspect the packaging carefully for damages or signs of rough handling. Report damage to the carrier and to the local office of the manufacturer.



INFORMATION!

Do a check of the packing list to make sure that you have all the elements given in the order.



INFORMATION!

Look at the device nameplate to ensure that the device is delivered according to your order.



Figure 2-1: Standard scope of delivery

- ① Ordered sensor
- ② Documentation

Optional accessories

- SENSOFIT FLOW 1000 series - Flow-through assemblies
- SENSOFIT IMM 1000 / 2000 series - Immersion assemblies
- SENSOFIT INS 1000 / 7000 series - Insertion assemblies
- SENSOFIT RET / RAM 5000 series - Manual and pneumatic retractable assemblies
- Cable VP2-S (cable with shield in various lengths)
- SMARTMAC 200 W - Wall mount display with calibration and configuration function
- SD 200 W/R - Wall or rack mount indicator
- OPTIBRIDGE / SMARTBRIDGE – USB interface cable
- SJB 200 W-Ex– Junction box

Consumables / Spare parts available

- Various ORP solutions for sensor verification
- Various cleaning solutions



INFORMATION!

For further information contact your local sales office.

2.2 Device description

2.2.1 Device description

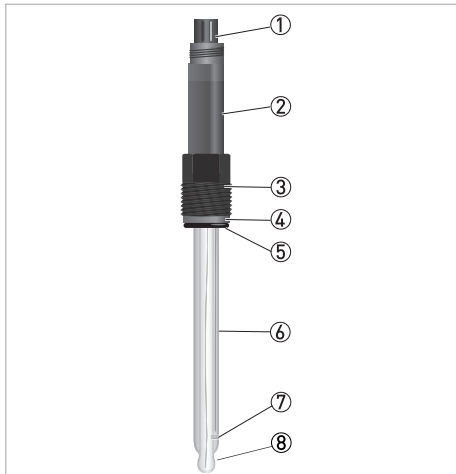

Figure 2-2: Construction of the ORP sensor

- ① VP2 connector
- ② Nickel plated brass body
- ③ Process connection: PG 13.5 thread
- ④ Washer
- ⑤ O-ring
- ⑥ Glass shaft
- ⑦ Diaphragm
- ⑧ Platinum electrode

2.3 Nameplate



Figure 2-3: Example for a nameplate on the sensor body

- ① Manufacturer
- ② Address
- ③ Device name
TAG number
- ④ Order code
Serial number
- ⑤ Manufacturing date / Ingress protection
- ⑥ Electronic/electric device waste marking;
Observe the operation and installation instruction / Approvals



Figure 2-4: Example for a nameplate on the glass shaft

- ① Manufacturer
- ② Device name



INFORMATION!

Look at the device nameplate to ensure that the device is delivered according to your order.

The sensor type is specified on the label of the sensor package and on the sensor itself.

3.1 General notes on installation

**DANGER!**

For devices used in hazardous areas, additional safety notes apply; please refer to the Ex documentation.

**DANGER!**

All work on the electrical connections may only be carried out with the power disconnected.

**DANGER!**

Observe the national regulations for electrical installations!

**WARNING!**

During installation of the device make sure that you use ESD (electrostatic discharge) protection equipment.

**WARNING!**

Observe without fail the local occupational health and safety regulations. Any work done on the electrical components of the measuring device may only be carried out by properly trained specialists.

**INFORMATION!**

Inspect the packaging carefully for damages or signs of rough handling. Report damage to the carrier and to the local office of the manufacturer.

**INFORMATION!**

Do a check of the packing list to make sure that you have all the elements given in the order.

**INFORMATION!**

Look at the device nameplate to ensure that the device is delivered according to your order.

3.2 Storage and transport

**CAUTION!**

Do not store the sensor tip dry. This will shorten lifetime considerably.

Always store the ORP sensor tip wet in a 3 molar KCl solution when not in use. Saltless water must be avoided since this would leak the KCl ions. The original packing in which the sensor tip was delivered contains a plastic tube with KCl solution and therefore is suitable for storage and transport.

- Since the ORP sensor is made out of glass it is very fragile. Avoid shocks of any kind.
- Do not touch or scratch the platinum electrode.
- Store and transport the device in a dry, dust-free environment.
- Store and transport the device in an environment with a temperature between 4...+30°C / 40...+86°F.
- The original packing is designed to protect the equipment. It has to be used if the device is transported or sent back to the manufacturer including the sensor transportation packing, to prevent damage of the sensor.

3.3 Pre-installation requirements

**CAUTION!**

- *Do not drop the device! Handle the device with care!*
- *Never touch or scratch the platinum electrode of the sensor.*
- *Store the sensor in its original packaging in a dry, dust-free location. Keep it away from dirt. If necessary, clean it. See cleaning procedure on page 27.*
- *Do not make any mechanical modifications to the sensor (electrodes shortened, drilled, bent or scratched). This can result in the loss of proper functionality, as well as the rights under the device warranty.*
- *The sensor must be suitable for the temperature, pressure and medium conditions which are specified (including chemical resistance).*

**INFORMATION!**

A sensor specific DTM software for usage with PACTware™ FDT is available. The DTM software is free of charge and available from CD (scope of delivery) or can be downloaded from the KROHNE website (Downloadcenter).

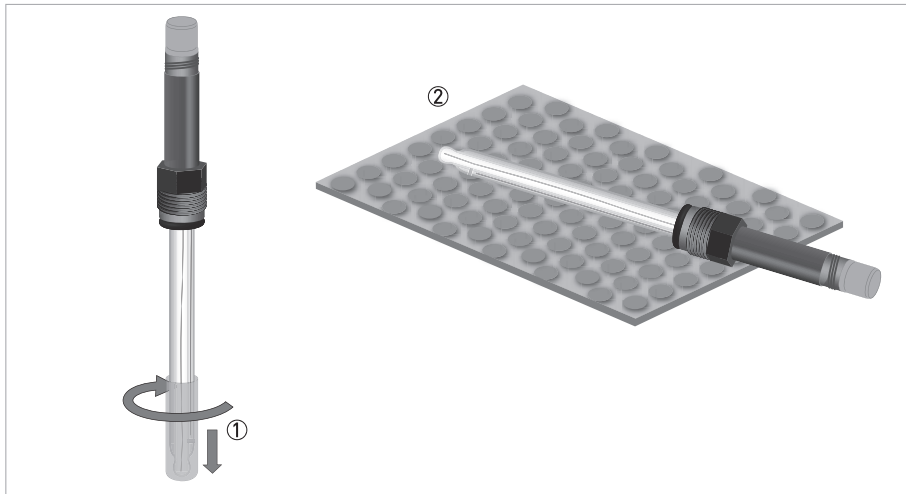

Figure 3-1: Unpacking the sensor



Unpacking the sensor

- Remove by gently twisting and pulling the protective cap from the sensor ①.
- Lay the sensor on a soft ESD mat or soft paper tissue ②.
- Leave the protection cap on the VP connector, as long as the sensor is not connected to the cable.

3.4 Installation procedure



WARNING!

During installation of the device make sure that you use ESD (electrostatic discharge) protection equipment.

Because a new ORP sensor needs to be calibrated before it is installed into its final measuring location, it is important to follow the installation order:



- ① Connect the sensor to the junction box or directly to the process control system.
- ② Calibrate the sensor.
- ③ Install the sensor into its final measuring location.

The required steps are explained in the following sections.

4.1 Safety instructions



DANGER!

For devices used in hazardous areas, additional safety notes apply; please refer to the Ex documentation.



DANGER!

All work on the electrical connections may only be carried out with the power disconnected.



DANGER!

Observe the national regulations for electrical installations!



WARNING!

Observe without fail the local occupational health and safety regulations. Any work done on the electrical components of the measuring device may only be carried out by properly trained specialists.



INFORMATION!

Look at the device nameplate to ensure that the device is delivered according to your order.

4.2 Power supply



CAUTION!

Do not use the integrate 250 Ohm HART[®] resistor of the SMARTMAC 200 W, when using an Ex isolation amplifiers of third-party with integrated 250 Ohm HART[®] resistor.

The sensor requires a minimum operating voltage of 15 VDC. The power supply is provided via the 2-wire interface (4...20 mA).

During initialisation of the sensor following values appear in the display mode of the "Measuring value":

Conductivity	NaN
Resistance	NaN
Temperature	NaN
Loop current	NaN

The specification NaN (Not a Number) disappears after a few seconds once the initialisation of the sensor is completed. Afterwards, the measured values appear.

4.3 Grounding and equipotential bonding

Sensor type SMARTPAT ORP must be grounded (hard grounding or capacitive connection to ground).

SJB 200 W-Ex junction box offers the grounding possibility.
For further information refer to the SJB 200 W-Ex manual.

For connection of SMARTPAT sensor use only a VarioPin cable with shield wire, like the cable VP2-S.

4.4 Connecting the cable to the sensor



WARNING!

During installation of the device make sure that you use ESD (electrostatic discharge) protection equipment.



CAUTION!

Moisture on the sensor connector must be avoided! Moisture may cause a short-circuit and a malfunction of the sensor!

If moisture has entered the connector dry it with air (e.g. hot air gun).

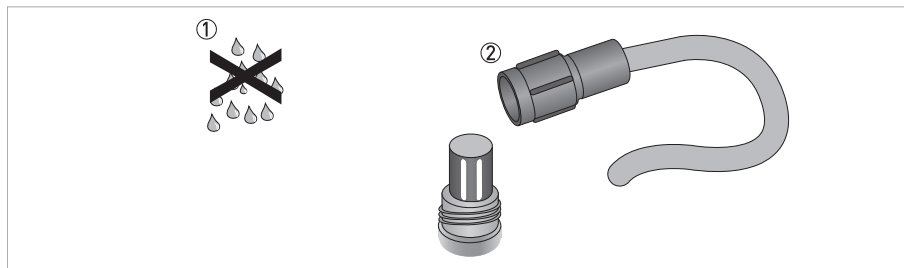

Figure 4-1: Connecting the cable to the sensor



Connecting the cable to the sensor

- Ensure that both cable and sensor connector are absolutely dry ①.
- Screw the cable connector ② on the sensor connector and tighten it by hand.

4.5 Connecting the sensor cable



DANGER!

All work on the electrical connections may only be carried out with the power disconnected.



INFORMATION!

The cable glands installed by the manufacturer are designed for a cable diameter of 8 mm...13 mm / 0,31"...0,51". If you are using cables with a larger diameter, you must replace the manufacturer's cable glands with suitable ones. The operator is responsible for the correct sealing of cable glands.

Cable VP2-S

Transparent-black (inner coax shield)	Ub+
White	Ub-
Shield	S

4.6 Connection diagram

Connection to SJB 200 W-Ex

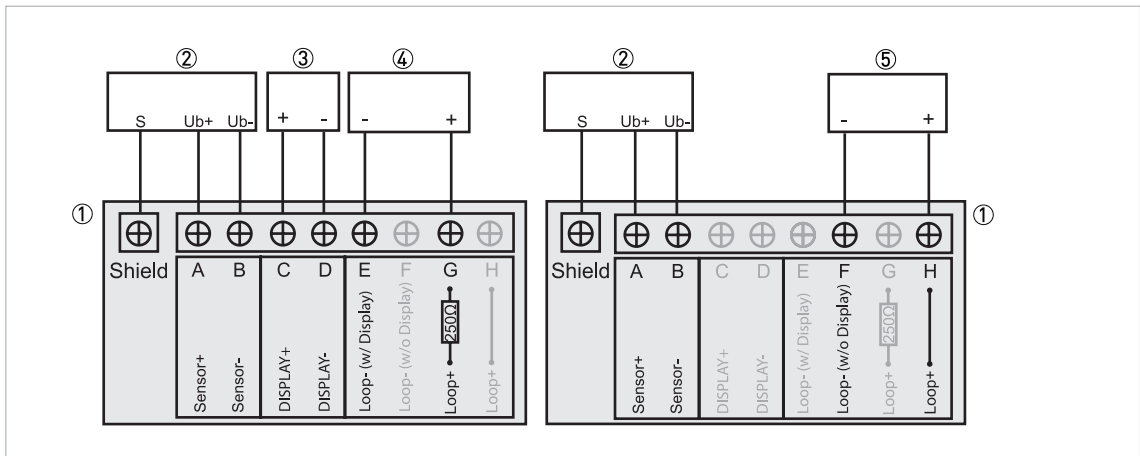

Figure 4-2: Example of a connection with a SJB 200 W-Ex junction box

- ① SJB 200 W-Ex junction box with or without internal resistor used
- ② Sensor with VP2-S cable
- ③ Display or other 4...20 mA loop powered device (e.g. data logger)
- ④ Control system without internal 250 Ω resistor connected to internal resistor of SJB 200 W-Ex
- ⑤ Control system with internal 250 Ω resistor connected to SJB 200 W-Ex without using internal resistor

SJB 200 W-Ex with internal resistor		SJB 200 W-Ex without internal resistor	
S	Shield	S	Shield
A	Sensor +	A	Sensor +
B	Sensor -	B	Sensor -
C	Display +	F	Loop - w/o Display
D	Display -	H	Loop +
E	Loop - w/ Display		
G	Loop + [250Ω]		

HART® interface within SJB 200 W

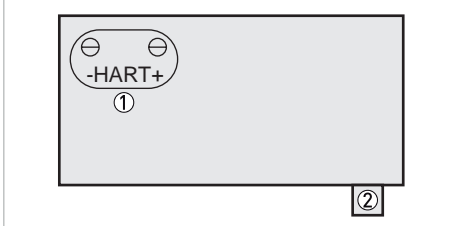

Figure 4-3: Example of a HART® handheld connection

- ① Connection via crocodile clips
- ② **Only for Ex:** M12 connector for the HART® handheld connecting cable

Connection of SMARTMAC 200 W with loop powered device via optional SJB 200 W-Ex junction box to a SMARTPAT Sensor.

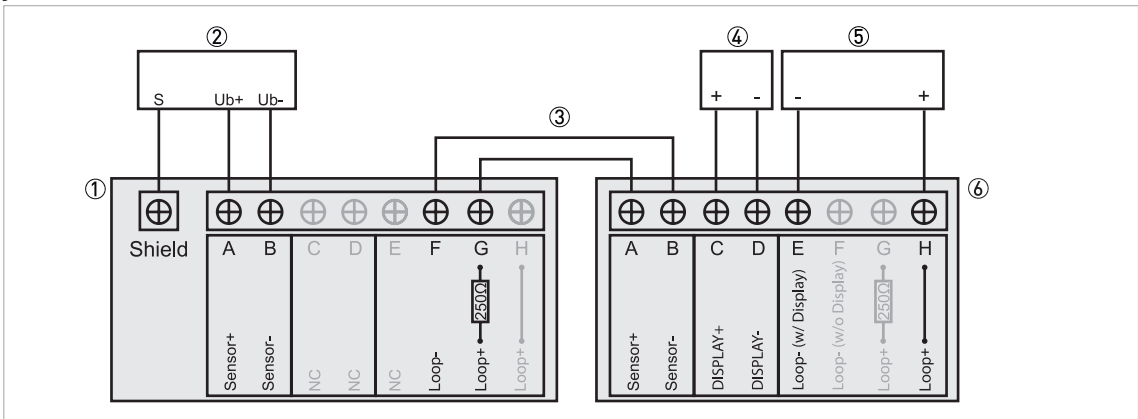

Figure 4-4: Example of connecting the SMARTMAC 200 W to a control system without internal 250 Ω resistor and one additional loop powered device.

- ① SMARTMAC 200 W
- ② Sensor with VP2-S cable
- ③ Cable connection between SJB 200 W-Ex and SMARTMAC 200 W
- ④ Display or other 4...20 mA loop powered device (e.g. data logger)
- ⑤ Control system without internal 250 Ω resistor
- ⑥ SJB 200 W-Ex junction box

SMARTMAC 200 W with internal resistor		SJB 200 W-Ex without internal resistor	
S	Shield	A	Sensor +
A	Sensor +	B	Sensor -
B	Sensor -	C	Display +
F	Loop -	D	Display-
G	Loop + [250Ω]	E	Loop - w/ Display
		H	Loop +



INFORMATION!

The SJB 200 W offers the opportunity to access the sensor via HART® hand held. For further information refer to the manual of the SJB 200 W.

Connection with sensor and control system

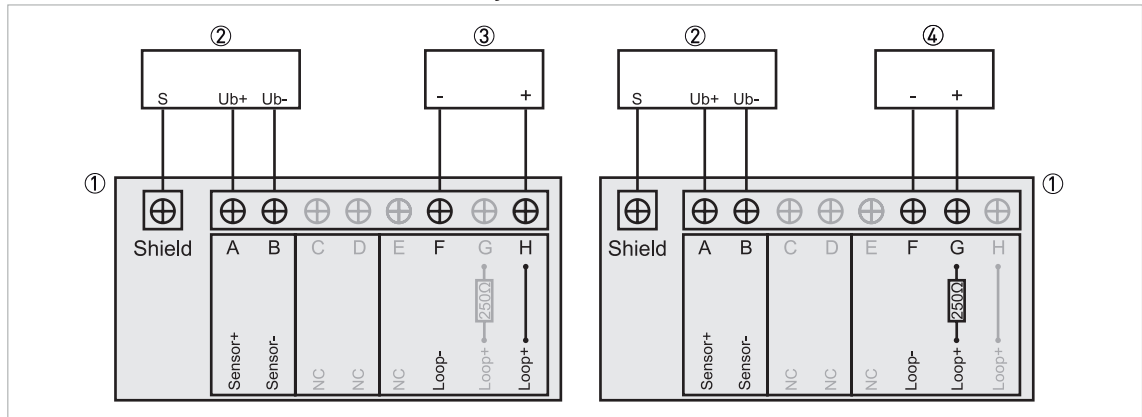

Figure 4-5: SMARTMAC 200 W connection to a control system with internal 250 Ω resistor (left side). SMARTMAC 200 W connection to a control system without internal 250 Ω resistor (right side).

- ① SMARTMAC 200 W
- ② Sensor with VP2-S cable
- ③ Control system with internal 250 Ω resistor
- ④ Control system without internal 250 Ω resistor

SMARTMAC 200 W without internal resistor		SMARTMAC 200 W with internal resistor	
S	Shield	S	Shield
A	Sensor +	A	Sensor +
B	Sensor -	B	Sensor -
F	Loop -	F	Loop -
H	Loop +	G	Loop + [250Ω]

4.7 Installing the sensor

4.7.1 General installation instructions



WARNING!

Ensure that the pipeline is without pressure before installing or removing a sensor!



INFORMATION!

During installation you should fix a shut-off valve in front of and behind the instrument so that the sensor can be taken out in case of check.



INFORMATION!

To achieve reliable measuring results, the electrodes must always have full contact with the measuring medium.



INFORMATION!

Basically any installation position is possible. However, ensure that sufficient medium flows through and around the electrodes (the conductive electrodes must always be completely surrounded by the medium). Structural measures must be taken to prevent flow interruption or gas bubbles.

4.7.2 General installation instructions

The sensor tip must always have full contact with the measuring medium.

The mounting position of the sensor should not deviate more than 75° from vertical position (sensor tip pointing downwards). Doing otherwise might cause internal air bubbles to float into the sensor tip. This would interrupt the electrical contact between the inner buffer solution and the platinum surface.

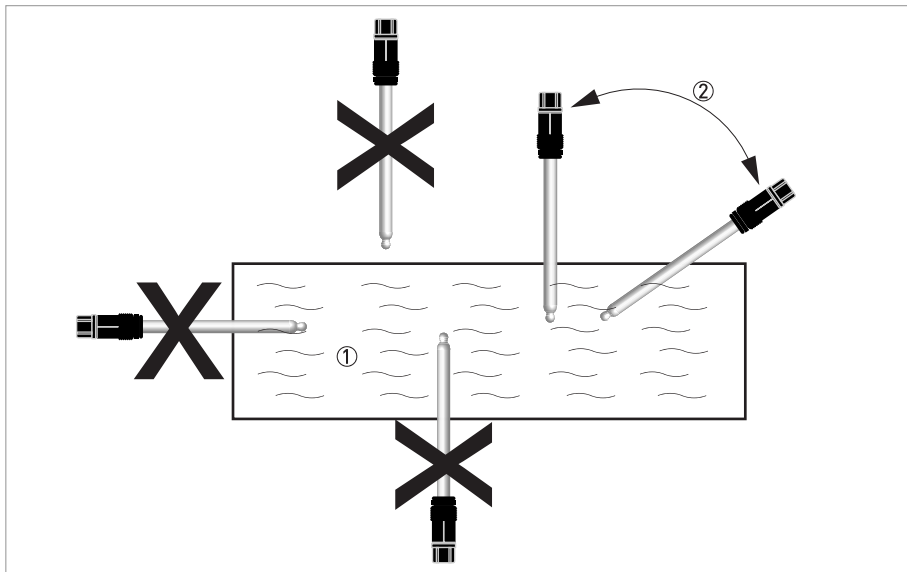

Figure 4-6: Installation requirements

- ① Measuring medium
- ② Maximum deviation of 75° from vertical position

4.7.3 Installation steps



- Ensure that the washer and the O-ring is properly fitted, clean and undamaged.
- Ensure that the raised face of the receiving part has a smooth surface
- Screw the device into the thread by hand.

Hand tight connection is sufficient.

For this device the max. torque that can be used is 7 Nm.

5.1 Calibration

5.1.1 Calibration with PACTware™



Manual hold

- Start the function **calibration** in menu mode **Quick Setup** or **Setup**.
- Activate the function **manual hold** to avoid an alarm.
- Select **yes**.
- Press **Next** to proceed.



Start calibration procedure

- Set value of ORP solution; Default setting: 468 mV
- Press **Next** to proceed.
- Dip the sensor into the ORP solution and wait till the value is stable.
- Press **Next** to proceed.
- ➔ The measurement of ORP solution starts. After approx.10 seconds and a successful calibration the following values appear:
 - Old ORP value in mV
 - ORP solution in mV
 - Electrode voltage in mV
 - New offset in mV
 - New ORP value in mV
- Press **Next** to proceed.
- Set the calibration date with DD-MM-YYYY.
- Press **Next** to proceed.
- ➔ The message **Save values?** appears.
 - Select **yes** to save the values.
 - Press **Next** to proceed.
 - Select **no** to deactivate function **manual hold**.
 - Press **Next** to leave the calibration menu.

A ORP calibration is necessary in regular intervals or when installing a new ORP sensor.

If the calibration was not successful, the message **Warning! Offset out of range!** appears behind the value **New offset**.



- Press **Next** to proceed.
- Set the calibration date with DD-MM-YYYY.
- Press **Next** to proceed.
- ➔ The message **Warning! Offset out of range!** appears.
 - Press **Next** to proceed.
 - ➔ The message **Save values?** appears.
 - Select between **yes** or **no**.
 - Press **Next** to proceed.
 - Select **no** to deactivate the function **manual hold**.
 - Press **Next** to leave the calibration menu.

**CAUTION!**

Make sure that the sensor tip is clean and dust-free. If necessary, clean the tip as described on page 27.

**CAUTION!**

Moisture on the sensor connector must be avoided! Moisture may cause a short-circuit and a malfunction of the sensor!
If moisture has entered the connector dry it with air (e.g. hot air gun).

5.1.2 Calibration with HART[®] Handheld 475 FIELD COMMUNICATOR

**Manual hold**

- Start the function **calibration** in menu mode **Quick Setup** or **Setup**.
- Activate the function **manual hold** to avoid an alarm.
- Select **Yes**.
- Press **Enter** to proceed.

**Start calibration procedure**

- Set value of ORP solution; Default setting: 468 mV. Press the key > to enter the submenu. Now you can change the default setting.
- Press **Enter** and **Ok** to proceed.
- Dip the sensor into the ORP solution and wait till the value is stable.
- Press **Ok** to proceed.
- ➔ The measurement of ORP solution starts. After approx. 10 seconds and a successful calibration the following values appear:
 - Old ORP value in mV
 - ORP solution in mV
 - Electrode voltage in mV
 - New offset in mV
 - New ORP value in mV
- Press **Ok** to proceed.
- Set the calibration date with DD-MM-YYYY. Press the key > to enter the submenu. Now you can change the calibration date .
- Press **Enter** and **Ok** to proceed.
- ➔ The message **Save values?** appear.
 - Press **yes** to save the values.
 - Press **Enter** to proceed.
 - Select **no** to deactivate the function manual hold.
 - Press **Enter** to leave the calibration menu.

A ORP calibration is necessary in regular intervals or when installing a new ORP sensor.

If the calibration was not successful, the message **Warning!!!** appears behind the value **New offset**.



- Press **Ok** to proceed.
- Set the calibration date with DD-MM-YYYY. Press the key > to enter the submenu. Now you can change the calibration date .
- Press **Enter** and **Ok** to proceed.
- ➔ The messages **Warning!!! Offset out of range!** and **Save values?** appear.
 - Select between **yes** or **no**.

- Press **Enter** to proceed.
- Select **no** to deactivate the function **manual hold**.
- Press **Enter** to leave the calibration menu.

**CAUTION!**

Make sure that the sensor tip is clean and dust-free. If necessary, clean the tip as described on page 27.

**CAUTION!**

Moisture on the sensor connector must be avoided! Moisture may cause a short-circuit and a malfunction of the sensor!

If moisture has entered the connector dry it with air (e.g. hot air gun).

5.2 Troubleshooting

Problem	Possible cause	Remedy
The ORP sensor does not deliver a signal.	Mechanical damage of the glass, e.g. small cracks.	Exchange sensor.
	Open circuit	Check the cable wiring of the sensor cable on the junction box. Otherwise connect the sensor to the primary master e.g. PACTware™ FTD/DTM or to the HART® handheld to exclude a sensor damage.
The ORP sensor delivers an unstable signal.	The diaphragm in the reference half cell does not provide good contact to the process medium due to drying up or coatings.	<ul style="list-style-type: none"> • Clean the diaphragm with hot soap or acid using a soft tissue (details on page 27). • Submerge sensor in water and increase the temperature to +50...+60°C / +122...+140°F. • Submerge sensor in 3 molar KCl solution at ambient temperature. The decrease in temperature will cause the reference half cell to suck in KCl solution through the diaphragm and regenerate the diaphragms functionality.
The ORP sensor does not deliver a HART® or 4...20 mA signal.	Open circuit or humidity between the connections.	Check the cable wiring of the sensor cable on the junction box. Otherwise connect the sensor to the primary master e.g. PACTware™ FTD/DTM or to the HART® handheld to exclude a sensor damage.
No ORP measurement.	Broken lead, incorrect electrical connection. Electrodes are exposed to air (not fully immersed).	Check the electrical connection again! Check the installation location: is liquid medium present?
No temperature measurement (only applicable via HART®DD or PACTware™ FTD/DTM).	Temperature sensor is faulty.	Exchange ORP sensor.

5.3 Status messages and diagnostic information

Measurements out of specification

Message	Description	Action
S01	ORP value > ORP max ORP value out of range	Consider the measuring range limits, otherwise select a suitable sensor for the process conditions of the application.
S02	ORP value < ORP min ORP value out of range	
S03	Temp. value > Temp max Temperature value out of range	
S04	Temp. value < Temp min Temperature value out of range	

Maintenance

Message	Description	Action
M01	Offset < -99 mV	Recalibrate the sensor. For more information refer to <i>Calibration with PACTware™</i> on page 23.
M02	Offset > +99 mV	
M03	Maintenance interval expired	

6.1 Maintenance

6.1.1 Cleaning



INFORMATION!

Recalibrate the sensor after each cleaning procedure.



- Slight dirt residues or dust: Rinse the sensor tip with demineralised water and clean it with a soft tissue.
- Oily and greasy coatings: Remove with a warm soap solution and rinse with demineralised water.
- Hardness deposits or metal hydroxide deposits: Soak the sensor tip including diaphragm in 10% citric acid or hypochloric acid for a couple of minutes and rinse the complete glass shaft of the sensor with demineralised water.
- Biological fouling: Soak the sensor tip including diaphragm in 10% pepsin solution for minimum 3 hours and afterwards rinse the complete glass shaft of sensor with demineralised water.

6.1.2 Aging and re-calibration

During operation, but already during storage, ORP sensors age due to poisoning effects of the inner buffer system. Therefore it is important to re-calibrate the sensor in regular intervals. Consider status messages and diagnostic information.



INFORMATION!

The lifetime expectation depends heavily on the application. The right choice of the sensor type is very important.

6.2 Availability of services

The manufacturer offers a range of services to support the customer after expiration of the warranty. These include repair, maintenance, technical support and training.



INFORMATION!

For more precise information, please contact your local sales office.

6.3 Returning the device to the manufacturer

6.3.1 General information

This device has been carefully manufactured and tested. If installed and operated in accordance with these operating instructions, it will rarely present any problems.



CAUTION!

Should you nevertheless need to return a device for inspection or repair, please pay strict attention to the following points:

- *Due to statutory regulations on environmental protection and safeguarding the health and safety of the personnel, the manufacturer may only handle, test and repair returned devices that have been in contact with products without risk to personnel and environment.*
- *This means that the manufacturer can only service this device if it is accompanied by the following certificate (see next section) confirming that the device is safe to handle.*



CAUTION!

If the device has been operated with toxic, caustic, flammable or water-endangering products, you are kindly requested:

- *to check and ensure, if necessary by rinsing or neutralising, that all cavities are free from such dangerous substances,*
- *to enclose a certificate with the device confirming that is safe to handle and stating the product used.*

6.3.2 Form (for copying) to accompany a returned device



CAUTION!

To avoid any risk for our service personel, this form has to be accessible from outside of the packaging with the returned device.

Company:		Address:	
Department:		Name:	
Tel. no.:		Fax no. and/or Email address:	
Manufacturer's order no. or serial no.:			
The device has been operated with the following medium:			
This medium is:	<input type="checkbox"/>	radioactive	
	<input type="checkbox"/>	water-hazardous	
	<input type="checkbox"/>	toxic	
	<input type="checkbox"/>	caustic	
	<input type="checkbox"/>	flammable	
	<input type="checkbox"/>	We checked that all cavities in the device are free from such substances.	
<input type="checkbox"/>	We have flushed out and neutralized all cavities in the device.		
We hereby confirm that there is no risk to persons or the environment through any residual media contained in the device when it is returned.			
Date:		Signature:	
Stamp:			

6.4 Disposal



CAUTION!

Disposal must be carried out in accordance with legislation applicable in your country.

Separate collection of WEEE (Waste Electrical and Electronic Equipment) in the European Union:



According to the directive 2012/19/EU, the monitoring and control instruments marked with the WEEE symbol and reaching their end-of-life **must not be disposed of with other waste**.

The user must dispose of the WEEE to a designated collection point for the recycling of WEEE or send them back to our local organisation or authorised representative.

7.1 Measuring principle

7.1.1 ORP measurement

The oxidation reduction potential, ORP in short, is the measurement for the concentration of oxidising and reducing agents in water. Its value is influenced both by pH and temperature. ORP is a sum parameter that gives no information on the concentration of a single substance in a mixture.

ORP measurements are used to monitor chemical reactions involving electron transfer. In drinking water treatment it can be found in ozone treatment and the removal of iron, manganese and nitrate as well as in disinfection steps. In swimming pools the German DIN 19643 requires ORP measurements as a hygiene parameter and decrees maximum and minimum values for fresh water, pool water, and salt water. In wastewater treatment ORP is measured in the denitrification process and in detoxication of industrial wastewater.

The ORP sensor consists of a measuring electrode of platinum or gold and a reference of e.g. Ag/AgCl. The potential of the measuring electrode changes with the concentration of reducing and oxidising agents and is measured against the reference. The measured values can be recalculated to fit literature values based on NHE (normal hydrogen electrode) as reference.

7.2 Technical data



INFORMATION!

- The following data is provided for general applications. If you require data that is more relevant to your specific application, please contact us or your local sales office.
- Additional information (certificates, special tools, software,...) and complete product documentation can be downloaded free of charge from the website (Downloadcenter).

Measuring system

Measuring principle	Potentiometric
Measuring range	-1500...+1500 mV

Design

Shaft diameter	12 mm / 0.47"
Insertion length	120 mm / 4.72"
Temperature sensor	Pt1000
Connector	VarioPin 2.0 (VP2)

Operating conditions

Process temperature	0...+70°C / +32...+158°F
Ambient temperature	-10...+85°C / +14...+185°F
Storage temperature	4...+30°C / +40...+86°F
Process pressure	Max. 2 bar / 30 psi
Conductivity	> 150 µS/cm

Installation conditions

Ingress protection	IP68
Weight	Approx. 80 g / 0.18 lb
Process connection	PG 13.5

Materials

Sensor shaft	Glass
Measuring electrode	Platinum
Inner buffer	pH 7.0
Reference	Ag/AgCl/TepoxGel
Diaphragm	Ceramic
O-Ring	EPDM (FDA)
Sensor head	Nickel plated brass body with VP2 connector

Communication

ORP range	-1500...+1500 mV
Output signal	4...20 mA (passive)
Output resolution	20 μ A
Field communication	HART [®] 7 - FSK 1200 physical layer definition on top of the current loop
Time constant	1...60 seconds

Electrical connections

Power supply	15...30 VDC loop powered
Measuring range	4...20 mA + HART [®] protocol
Load	Minimum 0 Ω ; maximum $R_L = ((U_{ext.} - 15 \text{ VDC}) / 22 \text{ mA})$
Error signal	Acc. to NAMUR NE 43
	Upper value: $\geq 21.0 \text{ mA}$
HART [®]	HART [®] protocol via current output
Device revision	1
Physical layer	FSK
Device category	Sensor, galvanically isolated
System requirements	250 Ω loop resistance for HART [®] communication
Multidrop operation	4 mA In a multidrop communication system, up to 32 devices can be connected. For installation in a multidrop communication system please consider the voltage drop for the 250 Ω loop resistance for HART [®] communication. The supply voltage has to be adjusted.

Approvals

CE	
This device fulfils the statutory requirements of the EC directives. The manufacturer certifies successful testing of the product by applying the CE mark.	
Shock resistance:	IEC 60068-2-31, Environmental testing – Part 2: Test Ec
Electromagnetic compatibility:	Acc. to EN 61326, NAMUR NE 21 EMC Directive 2004/108/EC (valid until 2016/04/19) or EMC Directive 2014/30/EU (valid from 2016/04/20)

**INFORMATION!**

For further information contact your local sales office.

7.3 Dimensions

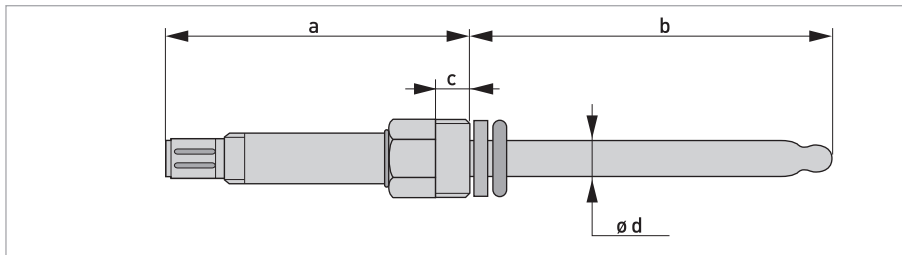

Figure 7-1: SMARTPAT PH 8510 with VP2

	Dimensions [mm]	Dimensions [inch]
a	104	4.09
b	120	4.72
c	12	0.47
d	$\varnothing 12$	$\varnothing 0.47$

8.1 General description

The open HART[®] protocol, which can be used for free, is integrated into the sensor for communication.

Devices which support the HART[®] protocol are classified as either operating devices or field devices. When it comes to operating devices (Master), both manual control units (Secondary Master) and PC-supported workstations (Primary Master) are used in, for example, a control center.

HART[®] field devices include sensors, signal converters and actuators. The field devices range from 2-wire to intrinsically safe versions for use in hazardous areas.

The HART[®] data are superimposed over the analogue 4...20 mA signal via FSK modem. This way, all of the connected devices can communicate digitally with one another via the HART[®] protocol while simultaneously transmitting the analogue signals.

When it comes to the field devices and secondary masters, the FSK or HART[®] modem is integrated. If a PC is used, an external modem must be connected to the serial interface (USB interface). There are, however, other connection variants which can be seen in the following connection figures.

8.2 Software history



INFORMATION!

In the table below, "x" is a placeholder for possible multi-digit alphanumeric combinations, depending on the available version.

Release date	SW version	HW version	HART [®]	
			Device Revision	DD Revision
2013-04-01	1.0.x	1.0.x	1	1
2015-12-01	1.0.x	1.0.x	1	2

HART[®] identification codes and revision numbers

Manufacturer ID:	69 [0x45]
Device:	194 [0xC2]
Device Revision:	1
DD Revision:	2
HART [®] Universal Revision:	7
FC 475 system SW.Rev.:	≥ 3.8
PDM version:	≥ 6.1
FDT version:	≥ 1.2

8.3 Connection variants

**CAUTION!**

For installation in a multidrop communication system please consider the voltage drop for the 250 Ω loop resistance for HART[®] communication. The supply voltage has to be adjusted.

The sensor is a 2-wire device with a passive 4...20 mA current output and HART[®] interface.

- **Multidrop mode is supported**

In a multidrop communication system, up to 32 devices can be connected to a common transmission cable.

- **Burst mode is not supported**

In the burst mode a slave device transfers cyclic pre-defined response telegrams, to get a higher rate of data transfer.

There are two ways of using the HART[®] communication:

- as Point-to-Point connection and
- as Multidrop connection, with 2-wire connection.

8.3.1 Point-to-Point connection - analogue / digital mode

Point-to-Point connection between the sensor and the HART® Master.

The current output of the sensor is passive.

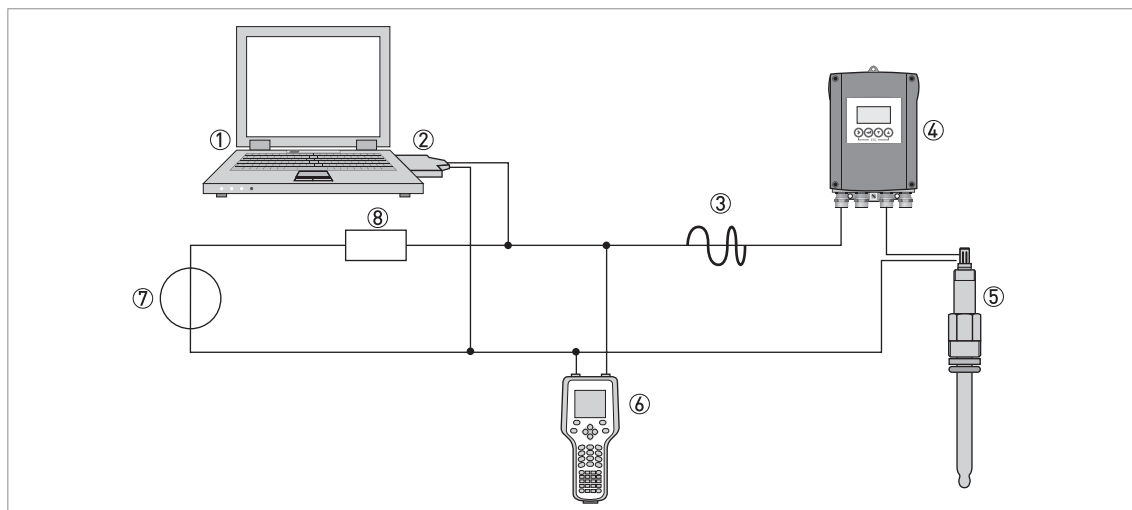

Figure 8-1: Point- to-Point connection

- ① Primary master with e.g. PACTware™ FDT/DTM
- ② FSK modem
- ③ HART® signal
- ④ SMARTMAC 200 W
- ⑤ SMARTPAT Sensor
- ⑥ Secondary master with HART® DD
- ⑦ Power supply for devices (slaves) with passive current output
- ⑧ Load $\geq 250 \Omega$ (Ohm)

8.4 Inputs/outputs and HART[®] dynamic variables and device variables

PV = Primary Variable; SV = Secondary Variable; TV = Tertiary Variable

HART [®] dynamic variable		
PV	SV	TV
ORP	Electrode voltage	Temperature

Code = device variable code

Device variables

HART [®] device variable	Code	Type
ORP value	0	linear
Electrode voltage	1	linear
Temperature	2	linear

The HART[®] dynamic variable PV is always connected to the HART[®] current output which is assigned to the ORP value.

8.5 Field Communicator 475 (FC 475)

The Field Communicator is a hand terminal from Emerson Process Management that is designed to configure HART[®] and Foundation Fieldbus devices. Device Descriptions (DDs) are used to integrate different devices into the Field Communicator.

8.5.1 Installation

The HART[®] Device Description for the sensor must be installed on the Field Communicator. Otherwise only the functions of a generic DD are available to the user and the entire device control is not possible. A "Field Communicator Easy Upgrade Programming Utility" is required to install the DDs on the Field Communicator.

The Field Communicator must be equipped with a system card with "Easy Upgrade Option". For details consult the Field Communicator User's Manual.

8.6 Field Device Tool / Device Type Manager (FDT/DTM)

A Field Device Tool Container (FDT Container) is basically a PC program used to configure a field device via HART®. To adapt different devices, the FDT container uses a so-called Device Type Manager (DTM).

8.6.1 Installation

If the DTM for the sensor has not yet been installed on the FDT Container, setup is required and is available for download from the website or on CD-ROM. See the supplied documentation for information on how to install and set up the DTM.

8.7 Overview Basic-DD menu tree (positions in menu tree)

Main menu	Submenu
1 Measuring value	1 ORP value
	2 Temperature
	3 Electrode voltage
	4 Loop current
	5 Error
	6 Device state
2 Quick setup	1 TAG
	2 Manual hold
	3 I/O
	4 Calibration
	5 Input user password
3 Logbook	1 Calibration logbook
	2 Error logbook
4 Setup	1 Process input
	2 I/O
	3 I/O HART®
	4 Device
5 Service	1 Service calibration
	2 Service parameter
	3 Passwords
	4 Sensor lock

8.8 Basic-DD menu tree (details for settings)

1 Measuring values

1 ORP value	Display of the measured ORP value on process control system, HART® handheld or display.
2 Temperature	Display of the measured temperature value in °C / °F on process control system, HART® handheld or display.
3 Electrode voltage	Display of the measured electrode voltage in mV on process control system, HART® handheld or display.
4 Loop current	Display of the measured loop current in mA on process control system, HART® handheld or display.
5 Error	Display of status messages and diagnostic information. For further information refer to <i>Status messages and diagnostic information</i> on page 26.
6 Device state	Display of status information icon for sensor according to NAMUR NE 107.

2 Quick setup

1 TAG	Set the TAG number for the measuring loop.	
2 Manual hold	Activate or deactivate the manual hold function. Select between yes or no.	
3 I/O	Meas. value at 4 mA	Set measuring value at 4 mA; Default setting: -1500 mV
	Meas. value at 20 mA	Set measuring value at 20 mA; Default setting: +1500 mV
	Time constant	Set time constant (1...60 seconds); Default setting: 1 second
4 Calibration	Start calibration procedure. For more information refer to <i>Calibration</i> on page 23.	
5 Input user password	Set password	

3 Logbooks

1 Calibration logbook	Logbook for the last 20 calibration cycles
2 Error logbook	Display errors

4 Setup

1 Process input	Temperature	Set temperature unit °C / °F		
		Set temperature offset		
		Display date of offset calibration		
	Calibration	Start calibration procedure. For more information refer to <i>Calibration</i> on page 23.		
	Maintenance interval	Set maintenance interval in days (000...999 days); Default setting: 000		
	Reset maintenance interval	Yes / No; Default setting: No		
2 I/O	Meas. value at 4 mA	Set measuring value at 4 mA; Default setting: -1500 mV		
	Meas. value at 20 mA	Set measuring value at 20 mA; Default setting: +1500 mV		
	Time constant	Set time constant (1...60 seconds); Default setting: 1 second		
3 I/O HART	TAG	Set TAG for measuring loop		
		Set long TAG		
		Display of previous long TAG		
	Message	Display messages (32 packed ASCII)		
	Polling address	Display polling address		
	Loop current mode	Select between enable or disable to activate or deactivate the loop current mode		
	Device variables	PV	Display PV - ORP with min. and max. limits	
		SV	Display SV - electrode voltage in mV	
TV		Display TV - temperature in °C / °F with min. and max. limits		

4 Device	Information	Sensor information	Order code
			Device name
			Serial number
			HART® ID
			Polling address
			Manufacturer ID
			Date of manufacturing
			SW version
			HW version
		Calibration	Offset
			ORP solution
			No. of calibrations
		Operating parameters (OP)	Commissioning date
			Operating hours
	OP time > 80°C / 176°F		
OP time > 110°C / 230°F			
Commissioning	Set date of commissioning	Max. temperature	

5 Service

1 Service calibration	Trimming at 4 mA (+/-)	
	Trimming at 20 mA (+/-)	
2 Service parameter	Reset of sensor	
	Load factory setting	
3 Password	Password protection	Activate or deactivate the password protection. Select between on and off.
	Password operator	Set password for operator
	Password administrator	Set password for administrator
	Reset password	Reset all passwords (only administrator)
4 Sensor lock	Select between YES or NO to lock the sensor. If you select YES the setting is not reversible anymore and the sensor is invalid for use. The HART® communication is not possible anymore.	







KROHNE – Process instrumentation and measurement solutions

- Flow
- Level
- Temperature
- Pressure
- Process Analysis
- Services

Head Office KROHNE Messtechnik GmbH
Ludwig-Krohne-Str. 5
47058 Duisburg (Germany)
Tel.: +49 203 301 0
Fax: +49 203 301 10389
info@krohne.com

The current list of all KROHNE contacts and addresses can be found at:
www.krohne.com

KROHNE